

SWIMMING POOL CONTROLLERS

BL120 · BL121

&

BL122 · BL123

WITH CLOUD CONNECTIVITY



INSTRUCTION MANUAL

**Dear
Customer,**

Thank you for choosing a Hanna Instruments® product.

Please read this instruction manual carefully before using this instrument.

This manual will provide you with the necessary information for correct use of this instrument, as well as a precise idea of its versatility.

If you need additional technical information, do not hesitate to e-mail us at tech@hannainst.com or view our contact list at www.hannainst.com.

TABLE OF CONTENTS

- 1. Preliminary Examination 5
- 2. Safety Measures 6
- 3. Abbreviations 6
- 4. Specifications 7
 - 4.1. Comparison Table for BL12X Swimming Pool Controllers 7
 - 4.2. Technical Specifications of BL120, BL121 & BL122, BL123 7
 - 4.3. HI1036-18XX* Probe Specifications 9
- 5. Description 10
 - 5.1. General Description & Intended Use 10
 - 5.2. Functional & Display Description 11
 - 5.3. Wiring 13
 - 5.4. Ethernet Cable Wiring (BL122 & BL123 Only) 14
- 6. Installation 15
 - 6.1. General Guidelines 15
 - 6.2. Installation Steps 15
 - 6.3. Mounting Recommendations for Saddle 18
 - 6.4. Connecting the Probe to the Pump Controller 19
 - 6.5. Installing the Aspiration Filter 20
 - 6.6. Installing the Injector 20
 - 6.7. Flow Cell Installation 21
 - 6.8. Cloud Connectivity (BL122 & BL123) 22
- 7. Setup 23
 - 7.1. User Interface 23
 - 7.2. General Setup Overview 25
 - 7.3. Parameters Setup Overview 26
 - 7.4. Hanna Cloud Setup (BL122 & BL123) 29
 - 7.5. Security Feature 30
 - 7.6. Analog Outputs (BL121 & BL123) 31
- 8. Operational Guide 32
 - 8.1. Calibration 32
 - 8.2. Measurement 36
 - 8.3. Controller Functioning Modes (Overview) 37
 - 8.4. Logging 40
 - 8.5. Log Recall 40

| | |
|---|----|
| 9. Event Management..... | 42 |
| 9.1. Warnings..... | 42 |
| 9.2. Alarms..... | 42 |
| 9.3. Process Errors..... | 43 |
| 9.4. System Errors..... | 44 |
| 10. Maintenance..... | 46 |
| 10.1. Electrode Conditioning & Maintenance..... | 46 |
| 10.2. Pump Tubing Replacement..... | 46 |
| 11. Accessories..... | 48 |
| Certification..... | 52 |
| Recommendations for Users..... | 52 |
| Warranty..... | 52 |

1. PRELIMINARY EXAMINATION

Remove the instrument and accessories from the packaging and examine it carefully. For further assistance, please contact your local Hanna Instruments® office or email us at tech@hannainst.com.

Two installation kit versions are available:

- **in-line** – [BL120-10](#), [BL121-10](#), [BL122-10](#), [BL123-10](#)
- **flow cell** – [BL120-20](#), [BL121-20](#), [BL122-20](#), [BL123-20](#)

Each instrument is delivered in a cardboard box and is supplied with:

| In-line mounting kit | Flow cell mounting kit |
|---|---|
| <ul style="list-style-type: none"> • HI1036-1802 Combined electrode (pH / ORP / Temperature) • Saddle for electrode, Ø 50 mm pipe (1 pc.) • Fittings for electrode • Injector (2 pcs.) • Saddle for injectors, Ø 50 mm pipe (2 pcs.) • Peristaltic pump tubing (2 pcs.) • Aspiration and injection tubing (5 + 5 m) • Aspiration filter (2 pcs.) • 7.01 pH Buffer solution (3 sachets) • 4.01 pH Buffer solution (3 sachets) • 470 mV ORP test solution (3 sachets) • Power cable • Instrument quality certificate • Instruction manual | <ul style="list-style-type: none"> • HI1036-1802 Combined electrode (pH / ORP / Temperature) • Panel mounted flow cell • Valve for flow cell connections with fittings and tubing (10 m) • Injector (2 pcs.) • Saddle for valves, Ø 50 mm pipe (2 pcs.) • Saddle for injectors, Ø 50 mm pipe (2 pcs.) • Peristaltic pump tubing (2 pcs.) • Aspiration and injection tubing (5 + 5 m) • Aspiration filter (2 pcs.) • 7.01 pH Buffer solution (3 sachets) • 4.01 pH Buffer solution (3 sachets) • 470 mV ORP test solution (3 sachets) • Power cable • Instrument quality certificate • Instruction manual |

Note: Save all packing material until you are sure that the instrument works correctly. Any damaged or defective item must be returned in its original packing material with the supplied accessories.

2. SAFETY MEASURES



- Do not use chlorine tablets, granular chlorine, or other non-liquid chlorine applications.
- Do not use the pool controller in a pool utilizing electrolytic chlorine generation (salt electrolysis).
- Do not add stabilizer (e.g. cyanuric acid) to the swimming pool while using the pool controller. To remove stabilizer from the pool, the pool must be drained and cleaned.
- Always disconnect the pool controller from power when making electrical connections.
- Do not access the larger rear panel.



- Do not run other cables with the power cable through the cable gland.

3. ABBREVIATIONS

| | |
|-------|-------------------------------------|
| DHCP | Dynamic Host Configuration Protocol |
| IP | Internet Protocol (address) |
| LED | Light Emitting Diode |
| ORP | Oxidation-Reduction Potential |
| REDOX | Reduction & Oxidation |
| SPDT | Single Pole Double Throw |

4. SPECIFICATIONS

4.1. COMPARISON TABLE FOR BL12X SWIMMING POOL CONTROLLERS

| | pH measurement | ORP measurement | Acid dosing pump | Chlorine dosing pump | Analog outputs | Hanna Cloud connectivity |
|-------|----------------|-----------------|------------------|----------------------|----------------|--------------------------|
| BL120 | ✓ | ✓ | ✓ | ✓ | | |
| BL121 | ✓ | ✓ | ✓ | ✓ | ✓ | |
| BL122 | ✓ | ✓ | ✓ | ✓ | | ✓ |
| BL123 | ✓ | ✓ | ✓ | ✓ | ✓ | ✓ |

4.2. TECHNICAL SPECIFICATIONS OF BL120, BL121 & BL122, BL123

| | |
|----------------------------|--|
| Range | 0.00 to 14.00 pH ± 2000 mV -5.0 to 105.0 °C (23.0 to 221.0 °F)* |
| Resolution | 0.01 pH 1 mV 0.1 °C (0.1 °F) |
| Accuracy @25 °C / 77 °F | ± 0.05 pH ± 5 mV ± 1.0 °C (± 1.8 °F) |
| Calibration | <ul style="list-style-type: none"> • pH buffer calibration: automatic, two points (4.01, 7.01, 10.01 pH) • pH process calibration: adjustable, single point • ORP (mV) calibration: adjustable, single point |
| Temperature compensation | <ul style="list-style-type: none"> • Automatic -5.0 to 105.0 °C (23.0 to 221.0 °F) for pH |
| pH Controller | <ul style="list-style-type: none"> • Proportional feed using adjustable set point and adjustable proportional band • Delay to start at power-on • Overdosing protection using overfeed safety timer |
| ORP Controller | <ul style="list-style-type: none"> • Proportional feed using adjustable set point and adjustable proportional band • Delay to start at power-on • Overdosing protection using overfeed safety timer • pH regulator interlocked |
| Alarms | <ul style="list-style-type: none"> • High and Low with enable / disable option for all parameters • Alarm is triggered after five consecutive readings over / under threshold |

*The range (pH & temperature) may be limited by the probe's limits.

| | |
|--|---|
| Log feature | <ul style="list-style-type: none"> • Automatic log • 60 days logging with 10 seconds period (or 100 logs) • pH / ORP / temperature measurements • Events: alarms / errors / power outage • Recall table / graphic modes • Export on USB key • Log files in CSV format |
| <p>Cloud connectivity BL122 & BL123 only</p> | <p>The BL122 & BL123 devices can connect to Hanna Cloud using a secured connection.</p> <ul style="list-style-type: none"> • Ethernet (RJ45) 10/100 Mbps connection • Device identity registry • Policy-based authorization of security keys <p>The instrument will send status information to Hanna Cloud with a defined period.</p> <ul style="list-style-type: none"> • Readings: pH / ORP / Temperature • Events: Alarms / Warnings / Errors • Peripheral status: LEDs • Last dosed acid and chlorine volumes • GLP info <p>The instrument will send setup information to Hanna Cloud at startup and whenever the setup is changed on the instrument.</p> <ul style="list-style-type: none"> • Alarm settings • Dosing settings • General settings • System: Meter information (model, FW version, OS version, serial number), Probe information (type, FW version, serial number) <p>The "Remote Hold" mode:</p> <ul style="list-style-type: none"> • is an emergency mode that can be remotely triggered via web application • in this mode the pumps are deactivated • can be canceled manually from the controller menu |
| Ethernet input BL122 & BL123 only | <ul style="list-style-type: none"> • Ethernet connector (RJ-45) 10/100 Mbps connection |
| Additional specifications | |
| Pump control | <ul style="list-style-type: none"> • Pump flow control 0.5 to 3.5 L/h (0.13 to 0.92 G/hour) and maximum output pressure 1 atm (14 psi) • Manual control for each pump |
| Password protection | <ul style="list-style-type: none"> • The setup, calibration and log recall features are password protected |
| Storage interface | <ul style="list-style-type: none"> • USB |
| GLP | <ul style="list-style-type: none"> • pH / ORP |
| Alarm system | <ul style="list-style-type: none"> • Intuitive alert system based on LED color coded alarm system • Alarm filtering options • Alarm relay control based on user setup filters |
| Alarm relay output | <p>SPDT 5A/230 Vac Activated by selectable pH / ORP / Temperature alarm conditions</p> |

| | |
|--------------------------------------|---|
| Analog outputs BL121 & BL123 only | <ul style="list-style-type: none"> • Three configurable analog outputs, 4 to 20 mA, sourcing • Output impedance $\leq 500 \Omega$ • Accuracy $< 0.5 \% FS$ • Galvanic isolation, up to 50 V relative to earth |
| Three digital inputs | <ul style="list-style-type: none"> • Galvanic isolation, powered contact type • One input for low level in acid / base tank (contact open) • One input for low level in chlorine tank (contact open) • One input for Hold mode (contact open) |
| Single probe input | <ul style="list-style-type: none"> • Probe type: HI1036-18XX* pH / ORP / Temperature / Matching pin, combined digital probe • DIN waterproof connector • Galvanic isolation • RS485 interface |
| Power supply | 100 - 240 Vac |
| Power consumption | 15 VA |
| Environment | <ul style="list-style-type: none"> • 0-50 °C (32-122 °F) • Max. 95% RH non-condensing |
| Dimensions | 245 x 188 x 55 mm (73 mm with pumps) 9.6 x 7.4 x 2.2" (2.9" with pumps) |
| Weight | 1700 g (60 oz) |
| Casing | Wall mounted, built-in pump, IP65 rated |

4.3. HI1036-18XX* PROBE SPECIFICATIONS

| | | |
|-------------------------|--|-----------------------------------|
| Range | pH | 0.00 to 12.00 pH |
| | ORP | ± 2000 mV |
| | Temperature | 0.0 to 70.0 °C (32.0 to 158.0 °F) |
| Reference | Ag / AgCl reference electrode (3.5M KCl) | |
| Junction | Cloth | |
| Matching pin | Yes | |
| Body | PVDF | |
| Top thread | 3/4" NPT | |
| Cable length | 2, 5, 10, 15, 20 m (6'7", 16'5", 32'9", 49'3", 65'7") cable | |
| Connector | DIN connector | |
| Maximum pressure @25 °C | 3 bar (43.5 psi) | |
| Ordering codes | <p>HI1036-1802 probe with 2 m (6'7") long cable</p> <p>HI1036-1805 probe with 5 m (16'5") long cable</p> <p>HI1036-1810 probe with 10 m (32'9") long cable</p> <p>HI1036-1815 probe with 15 m (49'3") long cable</p> <p>HI1036-1820 probe with 20 m (65'7") long cable</p> | |

* XX - identifies the cable length

5. DESCRIPTION

5.1. GENERAL DESCRIPTION & INTENDED USE

The Hanna Instruments® **BL12X** swimming pool controllers are automatic systems, specially designed to measure and control pH and free-chlorine levels.

The chlorine level is measured based on the ORP or REDOX principle. An increase in the ORP value correlates with an increase in the free-chlorine level. pH and disinfectant testing are done together for efficient disinfection and control. The efficacy of sanitizers, such as chlorine, depends on a controlled pH value. The ORP value is the most consistent indicator of the sanitizing effectiveness of the pool or water treatment. Typically, 650-750 mV at 7.2 pH indicates proper water treatment.

The **BL122** & **BL123** offer the added benefit of allowing remote access and visualizing of measured data via Cloud connectivity. All measurements and main events are sent to Hanna Cloud through the Ethernet connection.

For **BL121** & **BL123** three analog outputs are available that allow to connect to an external chart recorder or datalogger to monitor any of the three measured parameters. The outputs are scalable, offering increased flexibility and better resolution as needed.

Any of the controllers can be paired with the **HI1036-18XX** digital probe. The probe incorporates pH, ORP and temperature sensors along with a matching pin. It was specially designed to detect a broken electrode based on a shifted ISO potential value, around 4 pH. The **HI1036-18XX** uses a Ag/AgCl reference with 3.5 M KCl. The ORP values are referenced to it. Measurement data stored on the probe is transferred to the controller via a digital connection; thus eliminating noise and static due to high impedance signals carried by the cable.

BL12X swimming pool controllers are available in two configurations:

- in-line, for direct probe installation and chemical injection fittings into existing piping
- flow cell, for calibration and probe maintenance without having to shut down the recirculation pump

For compliance monitoring, each of the **BL12X** family has a built-in datalogger. Measurement readings are logged every 10 seconds, with a new log starting for each new day or when the instrument is calibrated. Logged data include pH, ORP, and temperature values, last calibration data, setup configuration, and any event data. For review and storage, the users can transfer data to a PC using a flash drive and the USB port.

The **BL12X** swimming pool controller is an automatic system but it is advisable that users check the controller and verify pH and free-chlorine levels (in mg/L or ppm) in the pool using a portable colorimeter.

Main Features

- Two built-in peristaltic dosing pumps with Proportional control
- Manual control for pump priming
- Overfeed protection using overtime safety timer
- Resumes dosing on restart in case of power failure
- Level input to stop control without reagents
- Interlocked pH-ORP control (i.e. ORP control only runs when the pH set point has been reached)
- Multicolored LED indicators for dosing, meter status and service
- Real-time graph display
- Programmable alarms
- Password protection

Main Benefits

- All-in-one solution for automatic control of pH and chlorine levels
- ORP (chlorine) dosing consent ensures pH value is correct before dosing

5.2. FUNCTIONAL & DISPLAY DESCRIPTION

Front Panel

The front panel includes a custom display and keypad with tactile feedback. Normally the first line displays measurement readings and the second line displays temperature. Two LEDs indicate alarm status and service conditions. A red LED indicates fault condition. Two additional blue LEDs flash, indicating pump activation.

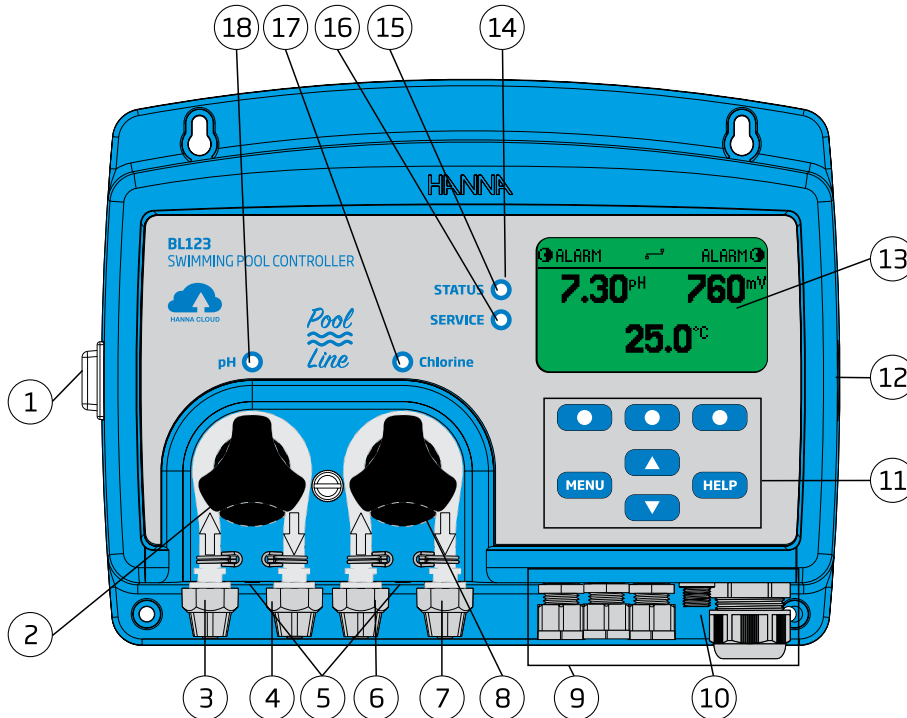

- | | | |
|---------------------|-------------------------|----------------------------------|
| 1. Power switch | 7. OUT chlorine | 13. Liquid Crystal Display (LCD) |
| 2. Acid dosing pump | 8. Chlorine dosing pump | 14. LED area |
| 3. IN acid | 9. Cable gland seals | 15. Status LED |
| 4. OUT acid | 10. Probe connector | 16. Service LED |
| 5. Drainage holes | 11. Keypad area | 17. Chlorine pump - status LED |
| 6. IN chlorine | 12. USB port (host) | 18. Acid pump - status LED |

Keypad Functions

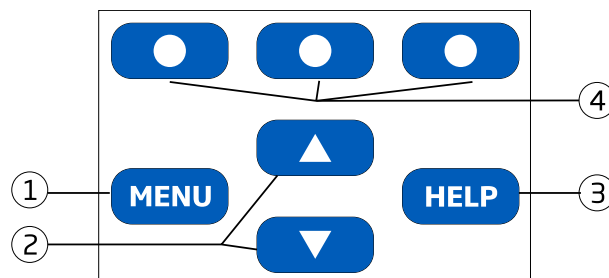

1. MENU key – Press MENU key to enter setup mode and access manual pump control; pH/ORP/Temperature options
2. ▲/▼ keys – When in MENU mode, press the arrow keys to scroll the menu items / adjust the settings
– When in measurement mode, press the arrow keys to change the screen: three parameter screen (pH, ORP, temperature), single parameter screen and plot display
3. HELP key – Enter / exit Help menu
4. Functional keys – Contextual functionality

Rear Sub Panel

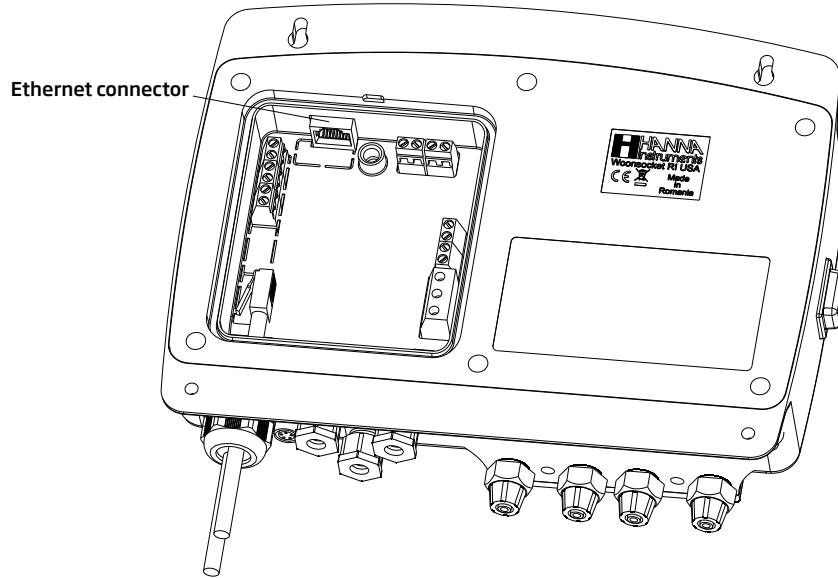

Note: The analog outputs – A01, A02, A03 – are available only for **BL121 & BL123**.
The Ethernet connector is available only for **BL122 & BL123**.



Warning! Always disconnect the Pool Controller from power when making electrical connections. Do not access the larger rear panel. User-serviceable terminals are found in the small sub panel only.

Use a Phillips head screwdriver and remove the single screw attaching the small back cover.

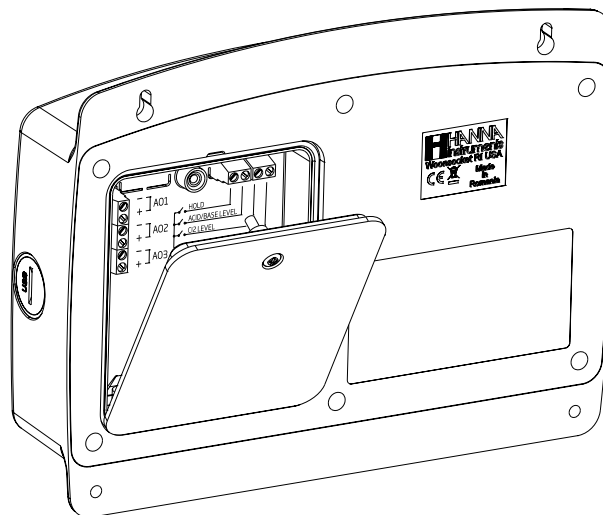

To replace the detachable rear panel, attach the bottom part of the panel to the controller and push to close. Tighten the screw that secures the panel to the housing.

5.3. WIRING

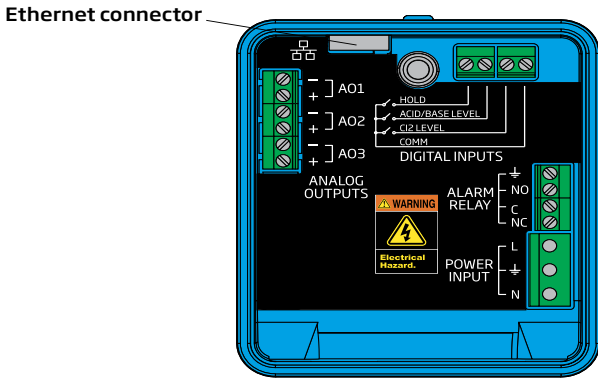

| | | | |
|-----------------------------------|-----------------|------------------|---------------|
| ANALOG OUTPUTS (BL121 & BL123) | A01 | + | 4 - 20 mA OUT |
| | | - | |
| | A02 | + | 4 - 20 mA OUT |
| | | - | |
| | A03 | + | 4 - 20 mA OUT |
| | | - | |
| ETHERNET (BL122 & BL123) | RJ-45 connector | | |
| DIGITAL INPUTS | | | |
| ALARM RELAY | | | |
| POWER INPUT | L | Line | |
| | | Protective Earth | |
| | N | Neutral | |

Note: The analog outputs – A01, A02, A03 – are available only for BL121 & BL123.

The Ethernet connector is available only for BL122 & BL123.



Warning! Always disconnect the Pool Controller from power when making electrical connections. Do not access the larger rear panel. User-serviceable terminals are found in the small sub panel only.

There are four openings for wiring:

- The left rear openings, for power and digital input wiring
- The left front opening, for alarm relay wiring
- The larger right opening, for analog output wiring (BL121 & BL123) and the ethernet cable (BL122 & BL123)
- Sensor wiring is made using the connector with threaded seal

Note: Do not run power cabling through the same opening as other cables.

All unused openings must be sealed with conduit plugs.

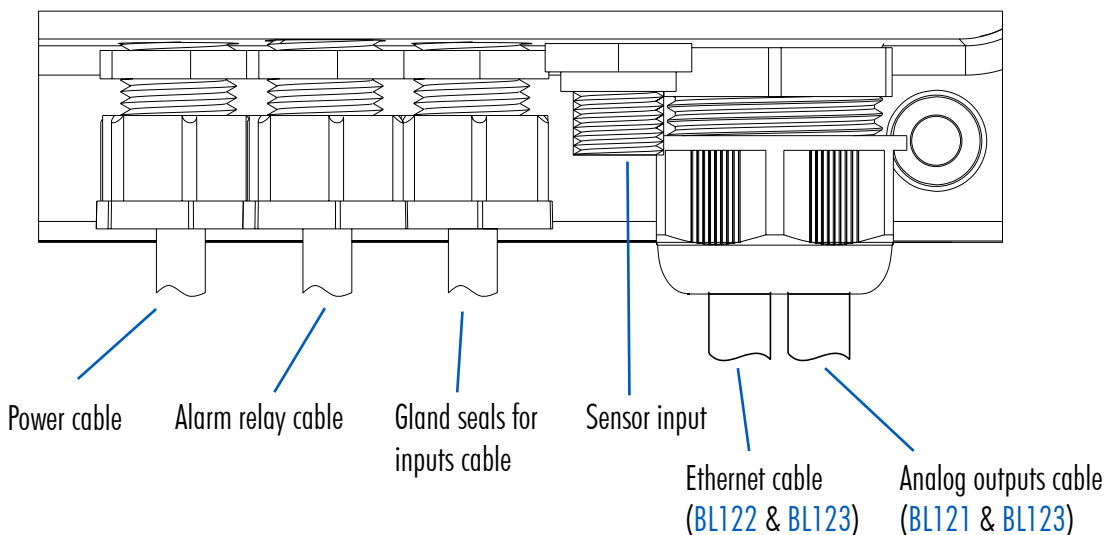

5.4. ETHERNET CABLE WIRING (BL122 & BL123 ONLY)

1. Insert the ethernet cable through the knurled nut and the slotted rubber seal.
2. Insert the ethernet cable through the casing into the housing.
3. Insert the analog output connection cable through the same knurled nut and slotted rubber seal. Use a 6 conductor wire cable.
4. Feed the cables through the seal to reach intended terminals.
5. Insert the rubber seal into the housing, then tighten the connection by turning the knurled nut clockwise.

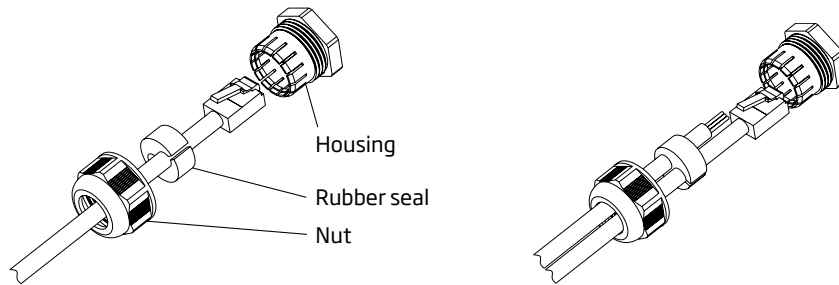

Note: For *BL123* always connect the analog output connections before connecting the ethernet cable.

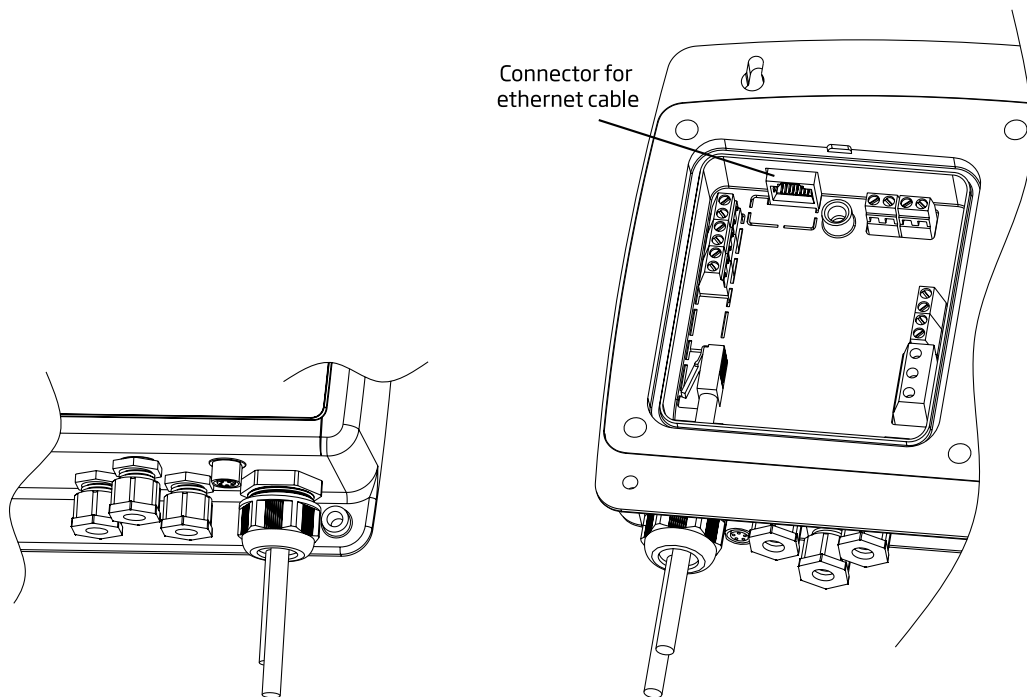

- Always disconnect the pool controller from power when making electrical connections.
- Do not access the larger rear panel.
- Do not run other cables with the power cabling.
- User-serviceable terminals are found in the small sub panel only.
- Do not run power cabling through the same opening as other cables.

6. INSTALLATION

There are two available configurations:

- In-line, with the probe placed in saddle, mounted on pipe after the pool filter.
- Flow cell, with the probe mounted in the flow cell, close to the controller. The water sample is directed to the flow cell via a small diameter sample line with appropriate connections (provided).

With flow cell configurations, the water circulation can be stopped by closing the valve on the inlet while maintenance or calibration procedures are performed.

6.1. GENERAL GUIDELINES

Electrical connection, installation, start-up, operation and maintenance must be carried out by specialized personnel only.

- Select controller location so that it is shielded from direct sunlight, dripping water and excess vibrations.
- Keep flow rate as constant as possible for optimum sensor operation.
- Install cable gland fittings and plugs as needed, to properly seal the pump controller.
- For optimal operation, all tubing, cables, saddles and fittings must be properly connected.
- For in-line installation, the probe saddle should be positioned after the pool filter (within 2 m distance).

Caution! Use gloves, protective clothing, and eye protection goggles when working with injectors and tubing.

Note: Determine if a flow detector, alarm relays or analog outputs (BL121, BL123) will be used before mounting flow cell panel or pool controller, as access to rear sub panel is needed.

6.2. INSTALLATION STEPS

Note: Recirculation pump must be off.

1. Check the acid and chlorine reagent tank level.
2. Calibrate the probe before use in the system.
3. Mount the probe into saddle (in-line configuration) or in a flow cell.
4. Mount the injector saddles (see procedure).
5. Connect the flexible PVC aspiration tubing between filters in chemical tanks and inlet of pumps.
6. Connect the rigid PE dispensing tubing from the pump outlets to the injectors.
7. Check the level sensor's functionality (if used).
8. Check hold input functionality (if used).

BL12X controllers are shipped with two types of tubing, for both flow cell and in-line configurations:

- rigid tubing for outlet (dispensing) — connects the pump outputs to the injectors
- flexible tubing for inlet (aspiration) — connects the reagent filters to the pump inlets

In-Line Installation Overview & Components Table

Below is an illustrated reference of a generic, in-line installation scheme with the relevant components.

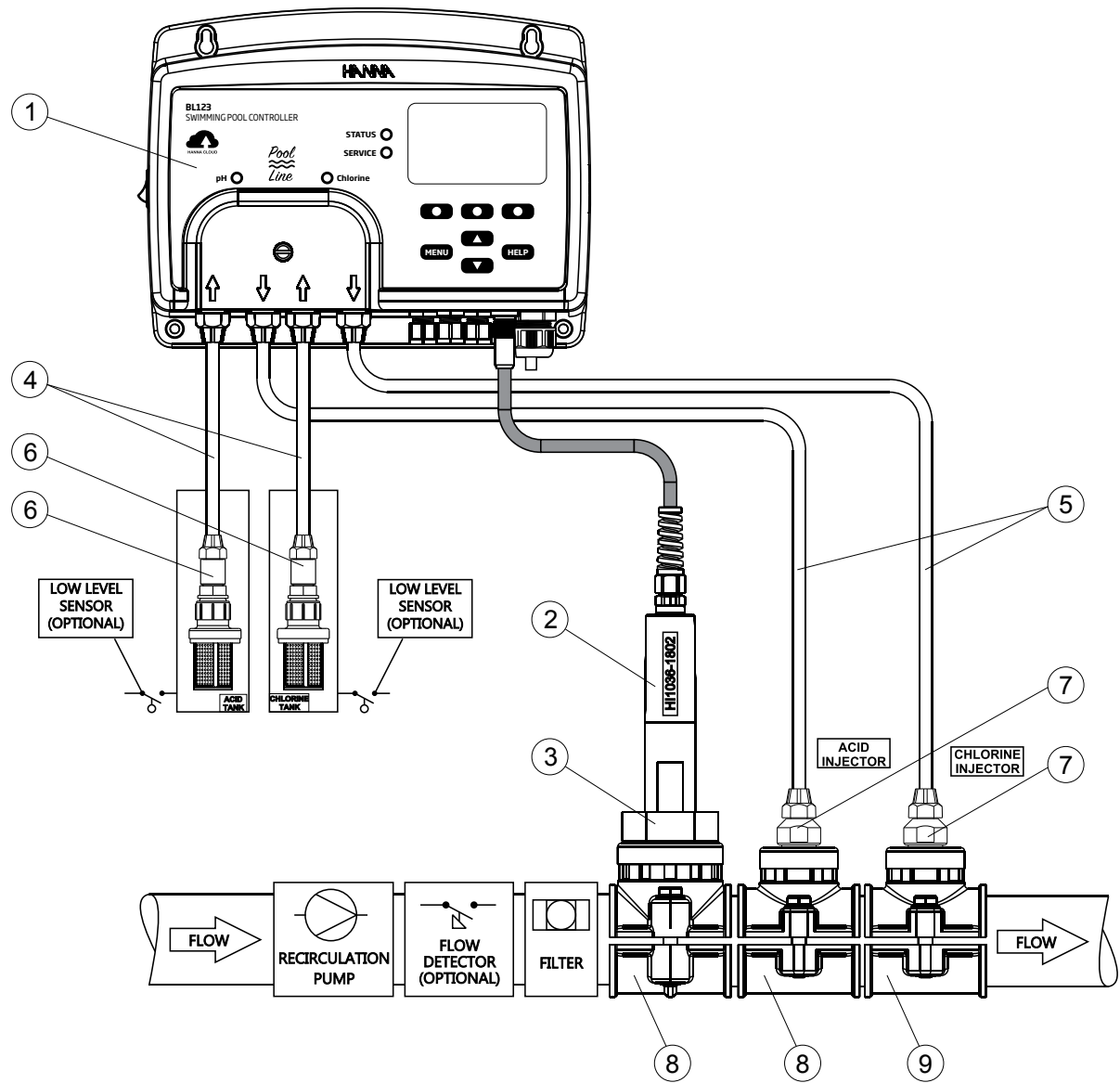

| Position | Component description |
|----------|--|
| 1 | Pool controller |
| 2 | pH/ORP/temperature electrode |
| 3 | Electrode fitting |
| 4 | Flexible tubing for pump input |
| 5 | Rigid tubing for pump output |
| 6 | Aspiration filter |
| 7 | Injector, 1/2" thread |
| 8 | Probe saddle for Ø 50 mm pipe, using 1/4" thread |
| 9 | Injector saddle for pipe, using 1/2" thread |

Note: Connections for flow detector and for level sensor (acid & chlorine tanks) are optional.

Flow Cell Installation Overview & Components Table

Below is an illustrated reference of a generic, flow cell installation scheme with the relevant components. The maximum pressure of the flow cell system is 3 atm (44 psi).

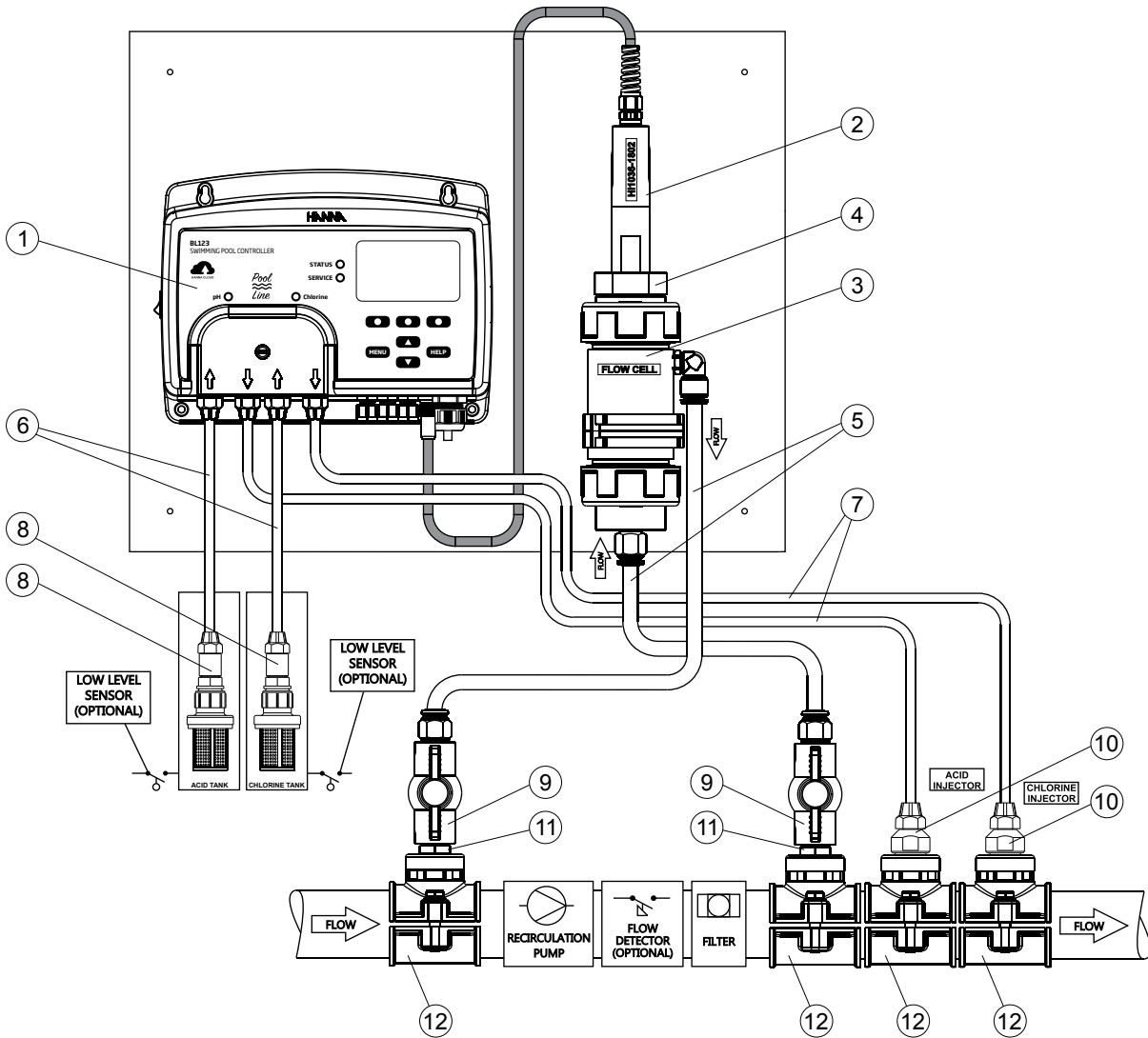

| Position | Component description |
|----------|---|
| 1 | Pool controller |
| 2 | pH/ORP/temperature electrode |
| 3 | Flow cell |
| 4 | Flow cell adapter |
| 5 | Flow cell tubing |
| 6 | Flexible tubing for pump input |
| 7 | Rigid tubing for pump output |
| 8 | Aspiration filter |
| 9 | Flow cell valve |
| 10 | Injector, 1/2" thread |
| 11 | Plastic nipple, 1/2" |
| 12 | Injector saddle for pipe, using 1/2" thread |

6.3. MOUNTING RECOMMENDATIONS FOR SADDLE

- Select required drill size. See table below for dimension details.

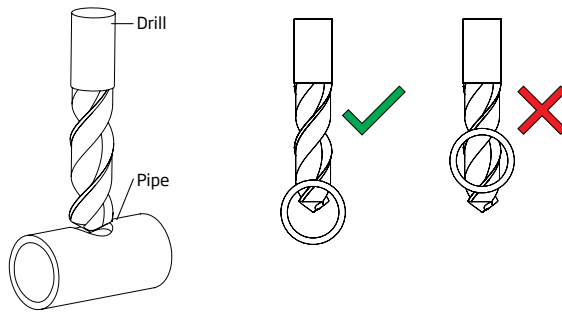

- Place the upper part of the saddle (5) on top of the pipe (3) with the seal (4) placed over the hole.
- Take the lower part of the saddle (2), together with inserted nuts (1) and align it under the upper part.
- Insert the screws (7) with washers (6) through the holes and hand tighten into the mounted nuts.
- With all the screws (7) in place, use a wrench to carefully tighten.
- Place the O-ring (8) provided into the upper saddle.

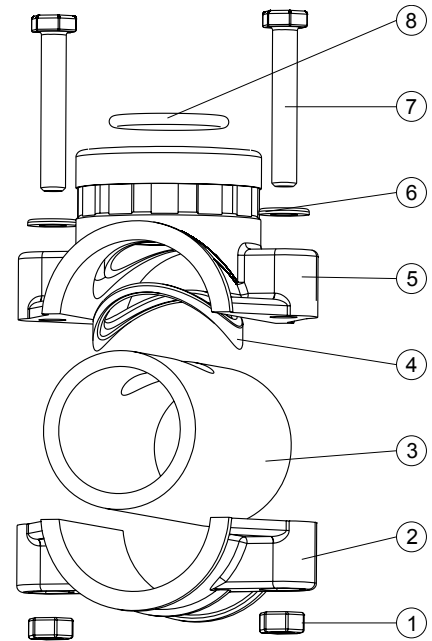

| Probe Saddle (In-line Configuration) | | Thread Size | Drill Size |
|--------------------------------------|--------------|-------------|-------------------------------|
| BL120-550 | Ø 50 mm pipe | 1 ¼"thread | 29 mm - 32 mm / 1.14" - 1.26" |
| BL120-563 | Ø 63 mm pipe | 1 ¼"thread | 29 mm - 32 mm / 1.14" - 1.26" |
| BL120-575 | Ø 75 mm pipe | 1 ¼"thread | 29 mm - 32 mm / 1.14" - 1.26" |

| Valve Fittings (Flow Cell Configuration) | | Thread Size | Drill Size |
|--|--------------|-------------|---------------------------------|
| BL120-450 | Ø 50 mm pipe | ½"thread | 20 mm - 25.4 mm / 0.79" - 1.00" |
| BL120-463 | Ø 63 mm pipe | ½"thread | 20 mm - 25.4 mm / 0.79" - 1.00" |
| BL120-475 | Ø 75 mm pipe | ½"thread | 20 mm - 25.4 mm / 0.79" - 1.00" |

| Injector Saddle | | Thread Size | Drill Size |
|-----------------|--------------|-------------|---------------------------------|
| BL120-250 | Ø 50 mm pipe | ½"thread | 20 mm - 25.4 mm / 0.79" - 1.00" |
| BL120-263 | Ø 63 mm pipe | ½"thread | 20 mm - 25.4 mm / 0.79" - 1.00" |
| BL120-275 | Ø 75 mm pipe | ½"thread | 20 mm - 25.4 mm / 0.79" - 1.00" |

6.4. CONNECTING THE PROBE TO THE PUMP CONTROLLER

Ensure the probe is connected and calibrated before installation.

1. Remove protective cap and verify the O-ring is in place.

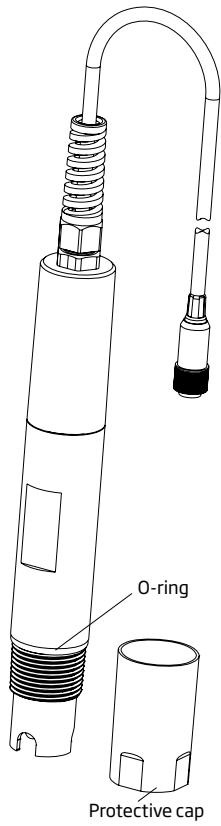

2. Insert the nut onto the probe.

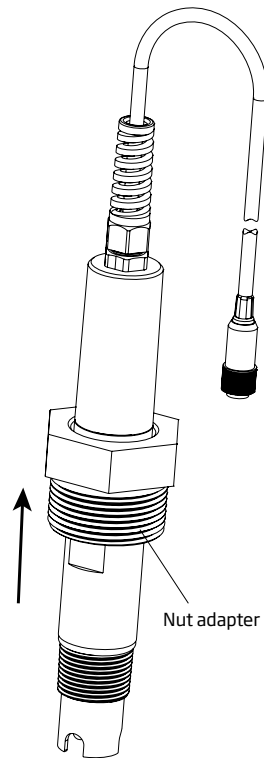

3. Carefully screw the adapter onto the probe taking care not to damage the O-ring.

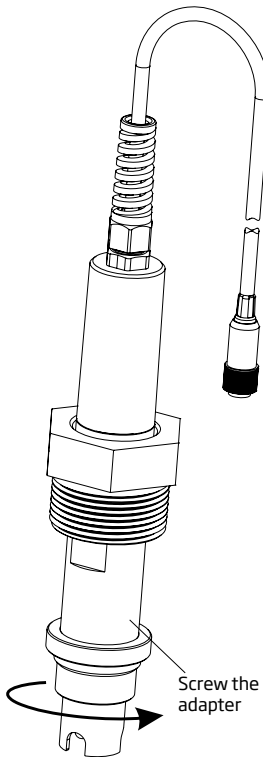

4. Insert the probe with the adapter and screw it carefully into the saddle.

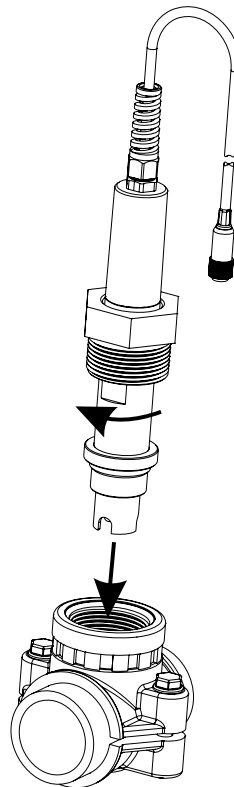

6.5. INSTALLING THE ASPIRATION FILTER

The aspiration filter is used in the reagent tank to filter and prevent debris from entering the tubing.

- Cut the required length of aspiration tubing (flexible) to reach between peristaltic pump inlet and aspiration filter.
- The nut should be placed on the tubing before it is connected. Place the end of tubing on the filter.
- The compression fitting has to be screwed in until tight on the filter.
- Slide the compression fitting from the peristaltic pump inlet onto the tubing.
- Slide the end of tubing over the fitting of the peristaltic pump tubing.
- Slide compression fitting up over tubing.
- Tighten the fitting.

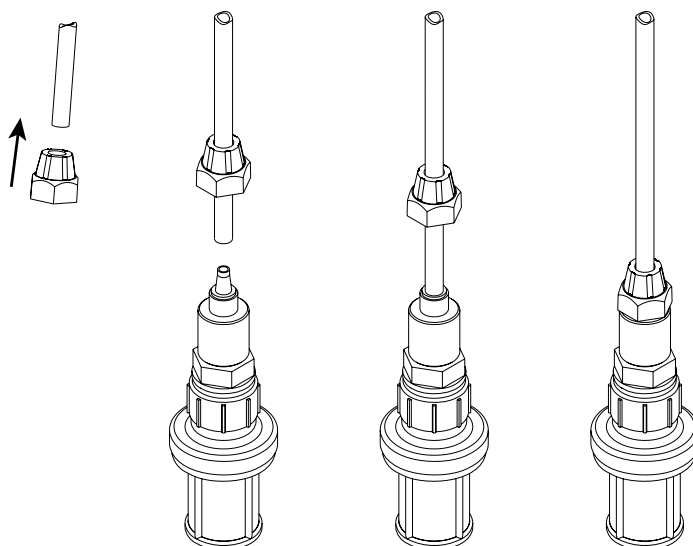

6.6. INSTALLING THE INJECTOR

- Cut required length of dispensing (rigid) tubing to reach between injector saddle and outlet of peristaltic pump.
- Place the compression fitting nut on the tubing.
- Place the end of tubing on the injector.
- The compression fitting has to be screwed in until tight on the injector.
- Screw the injector in the saddle.
- Slide compression fitting from pump tubing onto tubing.
- Slide the end of tubing over fitting of pump tubing.
- Slide compression fitting over tubing.
- Tighten the fitting to secure in place.

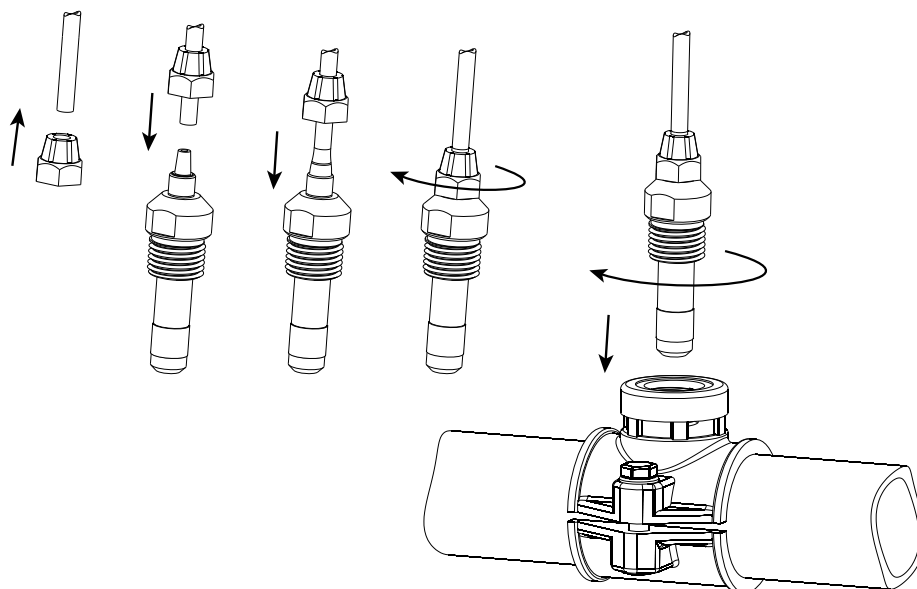

6.7. FLOW CELL INSTALLATION

In a flow cell configuration the water flows from the inlet valve to the flow cell and returns in the line via the outlet valve.

PART A Preparing the inlet and outlet valve assemblies

- Mount the saddle for flow cell inlet and outlet valve (follow mounting recommendations for saddle).
- Sparingly lubricate two O-rings (2) with a thin film of grease and mount them on both sides of the nipple (1).
- Screw the nipple into the saddle (3).
- Screw the valve (4) into the open end of the nipple mounted into the saddle. Make sure it is tight and the lever is facing forward so that it can be operated.
- Carefully screw the straight tubing fitting (5) into the valve, taking care not to damage the O-ring.
- Insert the tubing (6) in the straight tubing fitting (5).

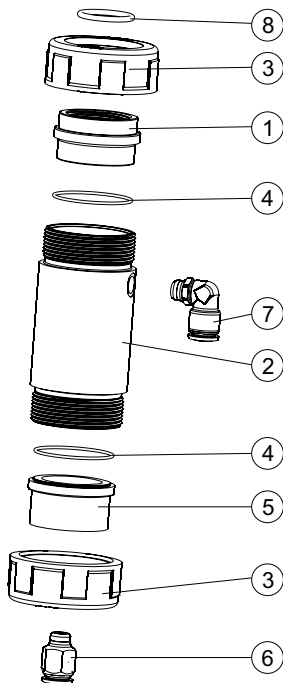
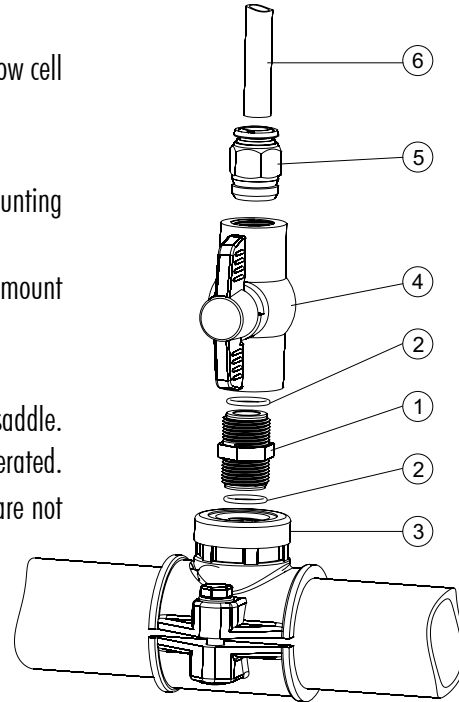

PART B Assembling and mounting the flow cell

- Place an O-ring (4) onto the flow cell cap (5) and insert the cap to the end of the flow cell tubing (2) without the hole on the side. Screw the flow cell nut (3) into place over the flow cell cap.
- Screw the straight tubing fitting (6) into the hole of the flow cell cap.
- Place an O-ring (4) onto the flow cell cap (1) and insert the cap onto the end of the flow cell tubing (2) with the hole in the side. Screw the flow cell nut (3) into place over the flow cell cap (1).
- Screw the elbow tubing fitting (7) into the side hole of the flow cell tubing (2).
- Place the supplied O-ring (8) into the flow cell cap (1).

PART C Connecting the probe to the controller

- Remove the protective cap and verify the O-ring (2) is in place.
- Insert the nut (5) into the probe. Carefully screw the adapter (4) into the probe, paying attention not to damage the O-ring.
- Mount the collar (7) onto the panel with the supplied screw.
- Insert the assembled flow cell (see part B) into the collar (7) and overlap the two collar wings. Hand press the overlapped wings until the collar clicks into position.
- Carefully insert the probe (3) into the flow cell, paying attention not to damage the O-ring. The adapter (4) mounted on the probe should now be inside the flow cell.
- Screw the nut (3) enough to secure the electrode and flow cell assembly in place.
- Insert the aspiration valve tubing (6a) into the saddle.
- Insert the dispensing valve tubing (6b) into the saddle.

Note: Prepare and calibrate the probe prior to installing in the flow cell.

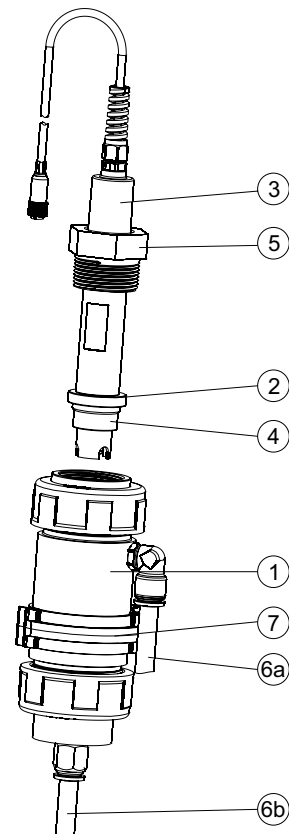

6.8. CLOUD CONNECTIVITY (BL122 & BL123)

Hanna Cloud is a web based application that connects users to measurement devices such as the [BL122](#) and [BL123](#). Measurements and data storage are accessible from a PC, tablet or phone with an internet connection.

Multiple registered devices may be connected.

Go to www.hannacloud.com webpage and follow the required steps to create an account.

After login, the Hanna Cloud user guide can be accessed, which contains detailed information on Hanna Cloud functionality.

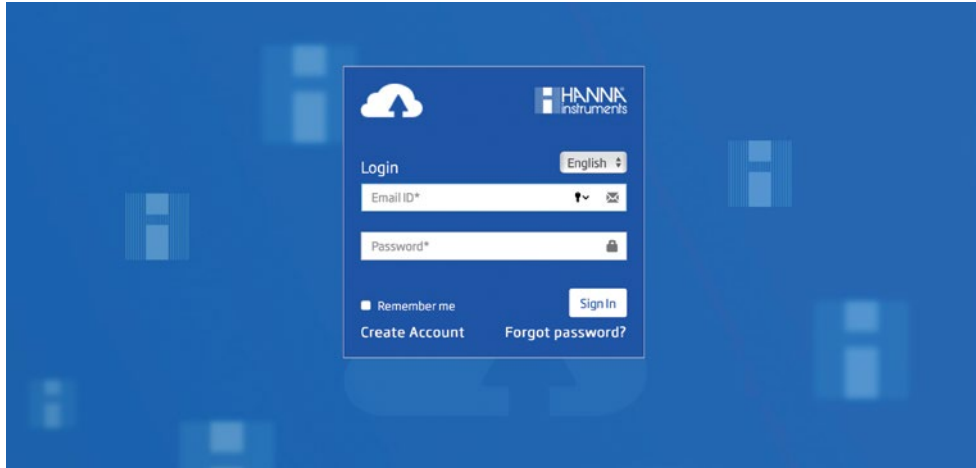

7. SETUP

7.1. USER INTERFACE

The controller menu is grouped into seven categories:

- Acid (or base) pump control
- Cl₂ pump control
- pH options (CAL, Setup, GLP)
- ORP options (CAL, Setup, GLP)
- Temperature options (Setup)
- Hanna Cloud options (BL122 & BL123)
- General options

BL120 & BL121 OVERVIEW

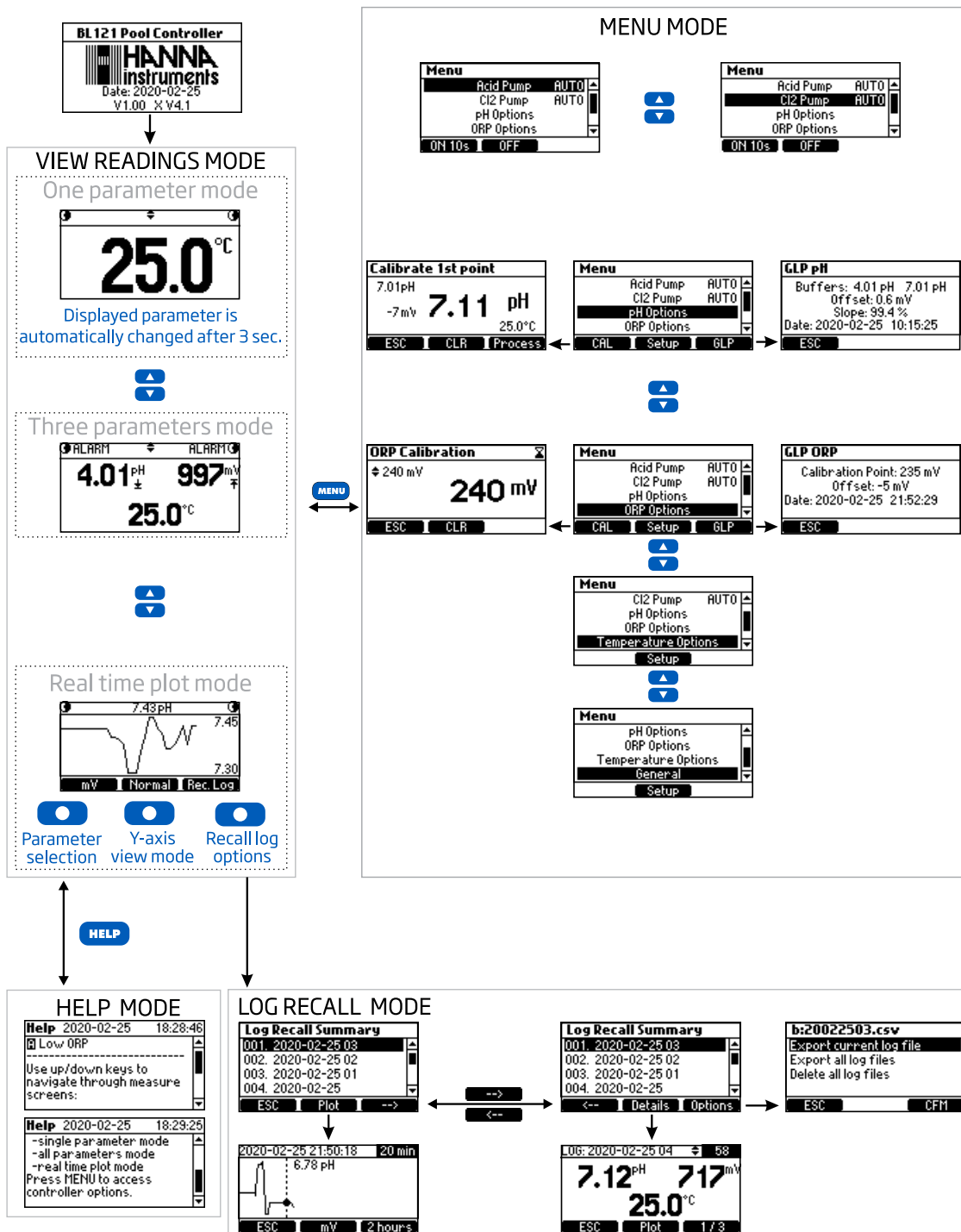

BL122 & BL123 OVERVIEW

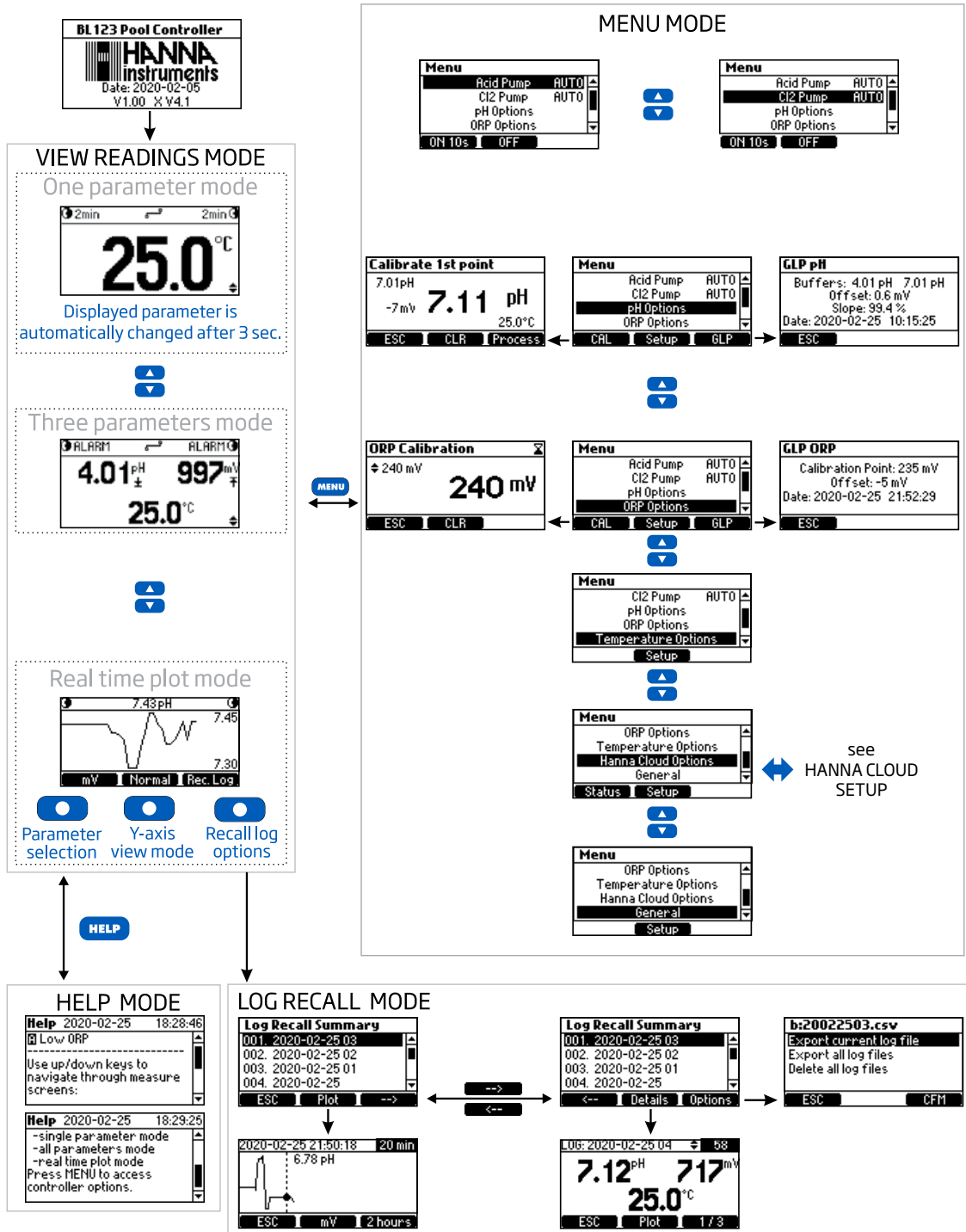

7.2. GENERAL SETUP OVERVIEW

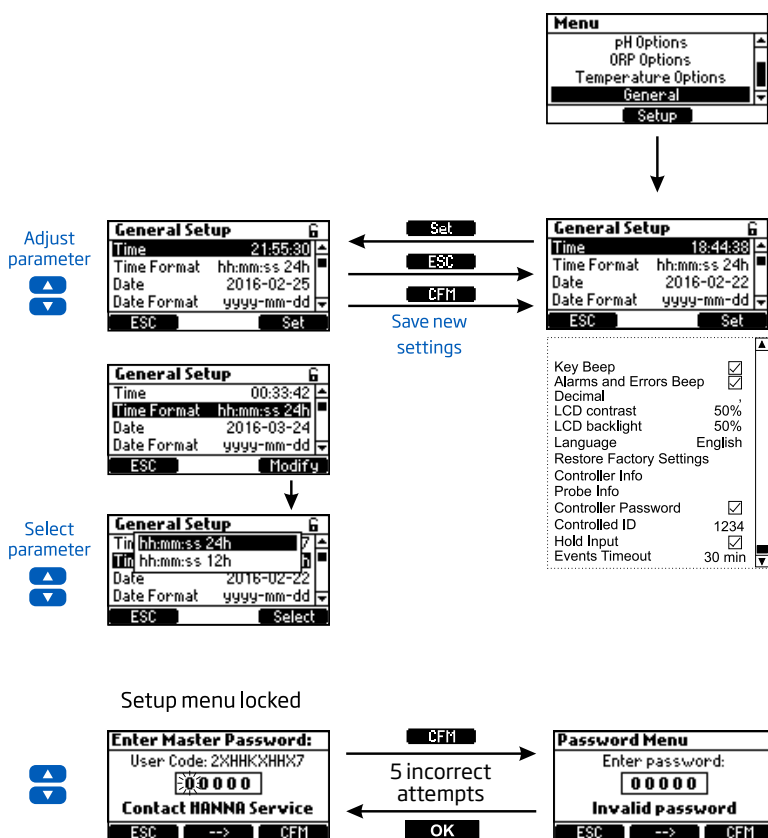

General Options

| Parameter | Range / Options | Default settings | Description |
|--------------------------|--|------------------|--|
| Time | Current set times | N/A | Modifies current time |
| Time Format | hh:mm:ss 24h hh:mm:ss 12h | hh:mm:ss 24h | Modifies current time format |
| Date | Current set date | N/A | Modifies current date |
| Date Format | yyyy-mm-dd, dd-mm-yyyy, mm-dd-yyyy, yyyy/mm/dd, dd/mm/yyyy, mm/dd/yyyy | yyyy-mm-dd | Modifies current date format |
| Key Beep | <input checked="" type="checkbox"/> Enable <input type="checkbox"/> Disable | Disabled | Enables/Disables the acoustic signal for key pressing |
| Alarms & Errors Beep | <input checked="" type="checkbox"/> Enable <input type="checkbox"/> Disable | Enabled | Generated when a new event is triggered |
| Decimal | Point / Comma | Point | Decimal separator |
| LCD Contrast | 0 % to 100 % / 1 % | 50 % | Display contrast |
| LCD Backlight | 0 % to 100 % / 1 % | 50 % | Backlight contrast |
| Language | English | English | User interface language |
| Restore Factory Settings | N/A | N/A | Restores user interface settings to default settings |
| Controller Info | N/A | N/A | Firmware version, language, serial number |
| Probe Info | N/A | N/A | Model, firmware version, serial number, factory calibration status |

| Parameter | Range / Options | Default settings | Description |
|---------------------|--|------------------|---|
| Controller Password | <input checked="" type="checkbox"/> Enable <input type="checkbox"/> Disable | Disabled | Protects against unauthorized use |
| Controller ID | 0 to 9999 / 1 | 1234 | Identifies the controller |
| Hold Input* | <input checked="" type="checkbox"/> Enable <input type="checkbox"/> Disable | Disabled | Enables or disables HOLD input for the recirculation pump |
| Events Timeout | 0 to 60 min / 1 min | 0 min. | This timer delays inactivating the pumps “control function” for this time period after an Alarm condition is triggered. (The pumps stay on during this time). |

*Feature has to be enabled in Setup and an optional in-line flow sensor has to be attached to the controller HOLD input (see digital input connections in WIRING section).

When the recirculation pump doesn't work, the flow sensor output should be open to trigger the HOLD mode (inactivates the dosing pumps).

7.3. PARAMETERS SETUP OVERVIEW

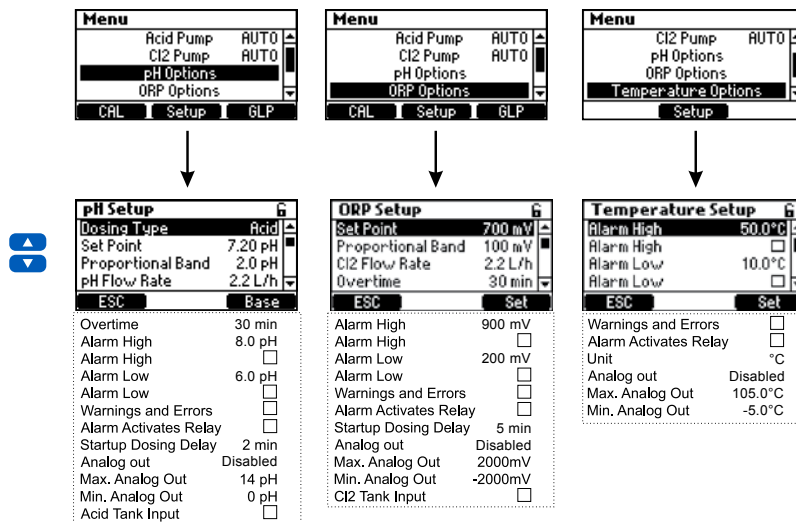

Note: The analog outputs – A01, A02, A03 – are only available for BL121 & BL123.

pH

| Parameter | Range / Options | Default settings | Description |
|-------------------|--|------------------|--|
| Dosing Type | Acid / Base | Acid | Switch between options, depending on the tank content |
| Set Point | 6.00 to 8.00 pH / 0.01 pH | 7.2 pH | Used to set required pH level When the acid pump is activated, the pump LED flashes |
| Proportional Band | 0.1 to 2.0 pH / 0.1 pH | 2.0 pH | pH regulated time proportional band. Proportions on/off time within the band. The pump is ON continuously at the set point value with added band |
| pH Flow Rate | 0.5 to 3.5 l/h / 0.1 l/h | 2.2 L/h | pH dosing pump flow rate |
| Overtime | 1 to 120 min / 1 min | 30 min | Maximum allowed dosing time in automatic mode |
| Alarm High | (pH Low + 0.1) to 14.0 pH Acid / 0.1 pH | 8.0 pH | Minimum pH value that triggers the alarm high if continuous for more than 5 seconds* Status and service LEDs are active and acid pump is disabled |

| Parameter | Range / Options | Default settings | Description |
|------------------------------------|--|------------------|--|
| Alarm High | <input checked="" type="checkbox"/> Enable <input type="checkbox"/> Disable | Disabled | Enables / Disables the pH high alarm |
| Alarm Low | 0.0 to (pH High-0.1) pH Acid / 0.1 pH | 6.0 pH | Maximum pH value that triggers the low alarm if continuous for more than 5 seconds** Status and service LEDs are active and acid pump is disabled |
| Alarm Low | <input checked="" type="checkbox"/> Enable <input type="checkbox"/> Disable | Disabled | Enables / Disables the pH low alarm |
| Warnings and Errors | <input checked="" type="checkbox"/> Enable <input type="checkbox"/> Disable | Disabled | Enables / Disables warnings and errors related to pH events |
| Alarm Activates Relay | <input checked="" type="checkbox"/> Enable <input type="checkbox"/> Disable | Disabled | Enables / Disables the relay control for pH events |
| Startup Dosing Delay | 1 to 180 min / 1 min | 2 min | The delay to start dosing at power-on |
| Analog Out (BL121 & BL123) | Disabled, A01, A02, A03 | Disabled | Assigns an analog output to pH reading |
| Max. Analog Out (BL121 & BL123) | 1 to 14 pH / 1 pH | 14 pH | High pH limit assigned to 20 mA |
| Min. Analog Out (BL121 & BL123) | 0 to 13 pH / 1 pH | 0 pH | Low pH limit assigned to 4 mA |
| Acid Tank Input | <input checked="" type="checkbox"/> Enable <input type="checkbox"/> Disable | Disabled | Enables / Disables the low level input in acid tank |

* The minimum adjustable value for alarm high is related to the value assigned to alarm low (if enabled).

** The maximum adjustable value of alarm low is related to the value assigned to alarm high (if enabled).

ORP

| Parameter | Range / Options | Default settings | Description |
|---------------------------|--|------------------|--|
| Set Point | 200 to 900 mV / 1 mV | 700 mV | Use to set the expected ORP level in pool |
| Proportional Band | 10 to 200 mV / 1 mV | 100 mV | ORP regulated time proportional band, proportions on/off time within the band The pump is on continuously at the set point value with added band |
| Cl ₂ Flow Rate | 0.5 to 3.5 l/h / 0.1 l/h | 2.2 l/h | ORP dosing pump flow rate |
| Overtime | 1 to 120 min / 1 min | 30 min | Maximum allowed dosing time in continuous mode |
| Alarm High | (Low + 1) to 1000 mV / 1 mV | 900 mV | Minimum ORP value that triggers the alarm high if continuous for more than 5 seconds* Status and service LEDs are active and Cl ₂ pump is disabled |
| Alarm High | <input checked="" type="checkbox"/> Enable <input type="checkbox"/> Disable | Disabled | Enables / Disables the ORP high alarm |
| Alarm Low | 0 to (High-1) mV / 1 mV | 200 mV | Maximum ORP value that triggers the alarm low if continuous for more than 5 seconds** Status and service LEDs are active and Cl ₂ pump is disabled |

| Parameter | Range / Options | Default settings | Description |
|------------------------------------|--|------------------|---|
| Alarm Low | <input checked="" type="checkbox"/> Enable <input type="checkbox"/> Disable | Disabled | Enables / Disables the ORP low alarm |
| Warnings and Errors | <input checked="" type="checkbox"/> Enable <input type="checkbox"/> Disable | Disabled | Enables / Disables warnings and errors related to ORP events |
| Alarm Activates Relay | <input checked="" type="checkbox"/> Enable <input type="checkbox"/> Disable | Disabled | Enables / Disables the relay control for ORP events |
| Startup Dosing Delay | 1 to 180 min / 1 min | 5 min | The delay to start dosing at power-on |
| Analog Out (BL121 & BL123) | Disabled, A01, A02, A03 | Disabled | Assigns an analog output to ORP reading |
| Max. Analog Out (BL121 & BL123) | -1999 to 2000 mV / 1 mV | 2000 mV | High ORP limit assigned to 20 mA |
| Min. Analog Out (BL121 & BL123) | -2000 to 1999 mV / 1 mV | -2000 mV | Low ORP limit assigned to 4 mA |
| Cl ₂ Tank Input | <input checked="" type="checkbox"/> Enable <input type="checkbox"/> Disable | Disabled | Enables / Disables the Cl ₂ the low level input tank |

Temperature

| Parameter | Range / Options | Default settings | Description |
|------------------------------------|--|----------------------|---|
| Alarm High | (Low + 0.1) to 100.0 °C / 0.1 °C (Low + 0.1) to 212.0 °F / 0.1 °F | 50.0 °C 122.0 °F | Minimum temperature value that triggers the alarm high event if continuous for more than 5 seconds* |
| Alarm High | <input checked="" type="checkbox"/> Enable <input type="checkbox"/> Disable | Disabled | Enables / Disables the temperature high alarms |
| Alarm Low | 0.0 to (High - 0.1) °C / 0.1 °C 32.0 to (High - 0.1) °F / 0.1 °F | 10.0 °C 49.9 °F | Maximum temperature value that triggers the alarm low event if continuous for more than 5 seconds** |
| Alarm Low | <input checked="" type="checkbox"/> Enable <input type="checkbox"/> Disable | Disabled | Enables / Disables the temperature low alarm |
| Warnings and Errors | <input checked="" type="checkbox"/> Enable <input type="checkbox"/> Disable | Disabled | Enables / Disables the warnings and errors related to temperature events |
| Alarm Activates Relay | <input checked="" type="checkbox"/> Enable <input type="checkbox"/> Disable | Disabled | Enables / Disables the relay control for temperature events |
| Unit | °C / °F | °C | Temperature measurement unit |
| Analog Out (BL121 & BL123) | Disabled, A01, A02, A03 | Disabled | Assigns an analog output to temperature reading |
| Max. Analog Out (BL121 & BL123) | -4.0 °C to 105.0 °C / 0.1 °C 24.8 to 221.0 °F / 0.1 °F | 105.0 °C 221.0 °F | High temperature limit assigned to 20 mA |
| Min. Analog Out (BL121 & BL123) | -5.0 °C to 104.0 °C / 0.1 °C 23.0 to 219.2 °F / 0.1 °F | -5.0 °C 23.0 °F | Low temperature limit assigned to 4 mA |

* The minimum adjustable value for alarm high is related to the value assigned to alarm low (if enabled).

** The maximum adjustable value of alarm low is related to alarm high value (if enabled).

7.4. HANNA CLOUD SETUP (BL122 & BL123)

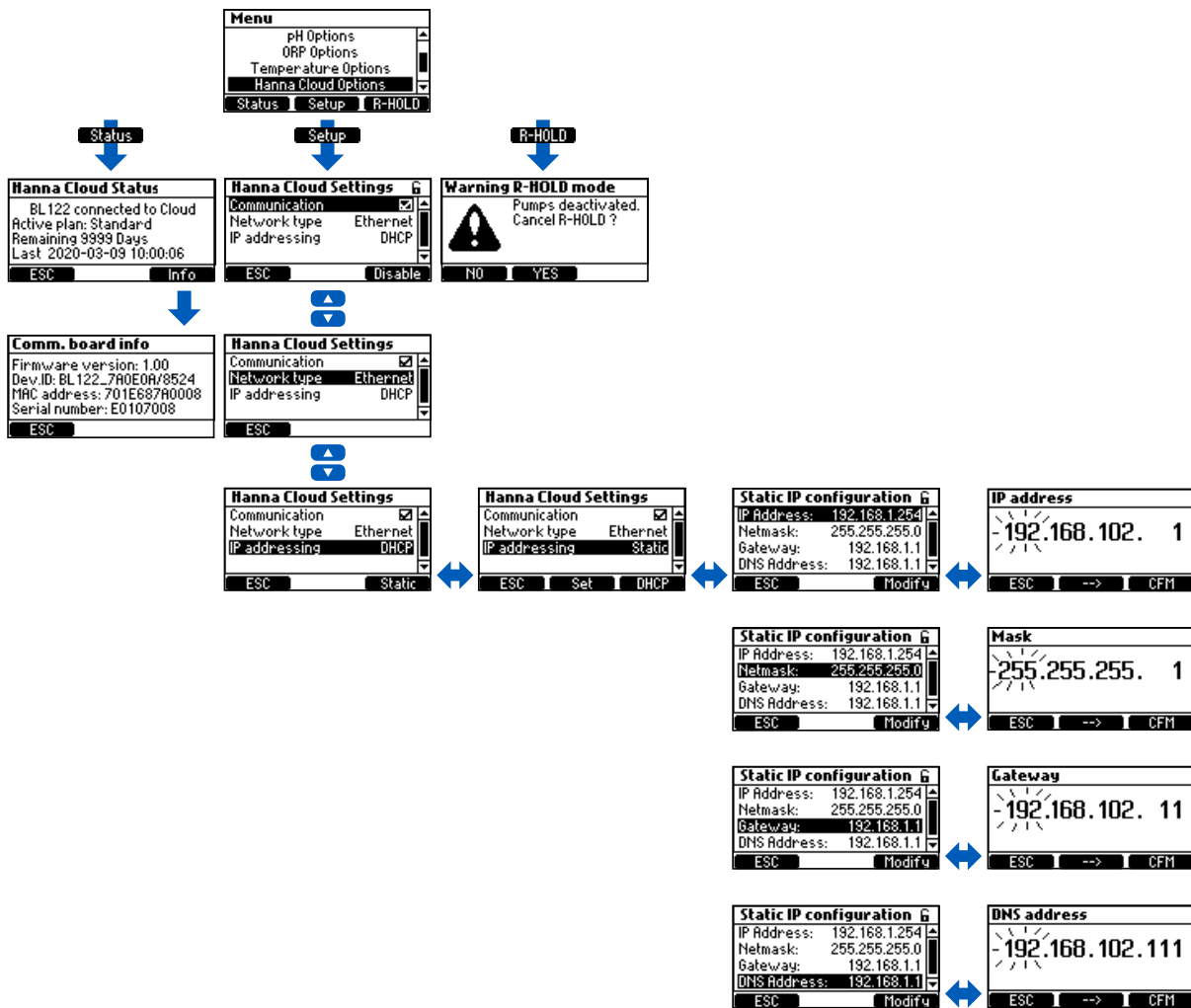

Hanna Cloud Options

These settings are required to permit Cloud monitoring of your pool.

IP addressing: An Internet Protocol address (IP address) is a numerical label assigned to each device connected to a network that uses the IP for communication. The DHCP (Dynamic Host Configuration Protocol) is a network management protocol whereby a DHCP server dynamically assigns IP addresses to the instrument. STATIC means that the installer of the instrument assigns a unique fixed address to the controller. This involves entering a four digit IP address, a four digit netmask (almost always 255.255.255.0), the IP address of the gateway (the router used to connect BL122 or BL123 to the rest of the internet) and the IP address of the DNS server.

| Parameter | Range / Options | Default settings | Description |
|---------------|--|------------------|---|
| Communication | <input checked="" type="checkbox"/> Enable <input type="checkbox"/> Disable | Enabled | Option to enable/disable Hanna Cloud communication module |
| Network Type | Ethernet | Ethernet | BL122 / BL123 network connection type |
| IP addressing | DHCP Static | DHCP | Option to select dynamic or static IP address |
| IP Address | addr01. addr02. addr03. addr04 | 192.168.1.254 | IP address |
| Netmask | netm01. netm02. netm03. netm04 | 255.255.255.0 | Netmask address |
| Gateway | gate01. gate02. gate03. gate04 | 192.168.1.1 | Gateway address |
| DNS Address | dns01. dns02. dns03. dns04 | 192.168.1.1 | DNS server address |

7.5. SECURITY FEATURE

The password protection feature protects against unauthorized configuration changes and logged calibration data erasure. Once set, a series of functions cannot be subsequently modified.

This feature is represented by the lock icon displayed on the functional key or on screen title.

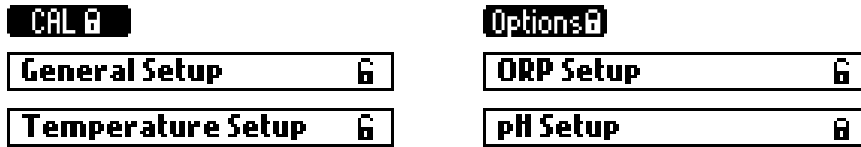

BL122 & BL123 offer an added password enabled security feature for the remote hold (R_HOLD) deactivation function (if password protection has been enabled).

- Select **Controller Password** from General Setup screen and press **Modify** to activate the feature.



- A five digit password has to be entered next.
- To change the digit value, press the ▼▲ keys.
- To move to the next digit, press the arrow functional key.
- Press **CFM** functional key to confirm.
- To disable the password, select **Controller Password** from General Setup screen, enter the password and press **CFM** functional key. After the correct password has been entered, press **Disable**.



Note: After five failed login attempts, the controller will require a master password. The master password can only be obtained from Hanna Instruments® Service. To issue the master password, Hanna® Service will request the user code displayed at the top of the screen.

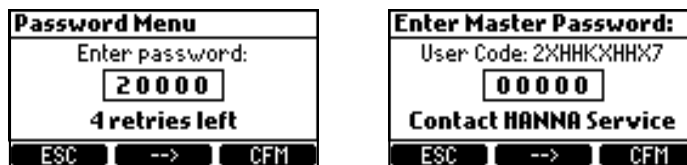

7.6. ANALOG OUTPUTS (BL121 & BL123)

The three 4-20 mA isolated current outputs are factory calibrated and can be configured through the Setup menu as pH / ORP or Temperature outputs.

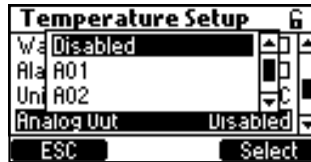
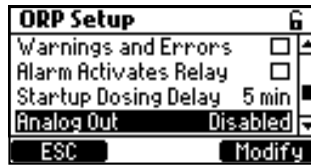
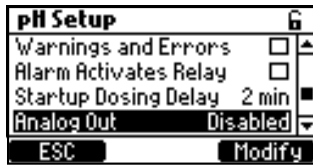

Each output can be disabled or configured to a parameter and can be connected to a chart recorder or data logger. The current signal is proportional to the assigned scale of the assigned parameter (e.g. A01 - pH, A02 - ORP, A03 - Temperature). To assign the output signal, select the minimum and maximum limit values for the parameter. The maximum and minimum values for each parameter are defined in the parameter Setup menu.

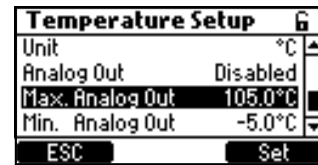
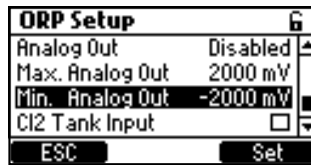
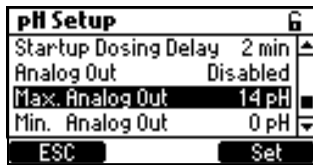

For example, if the pH was assigned to analog output 1 (A01) and the minimum and maximum analog output limits are 0 and 14 pH, the entire range will correspond to 4 and 20 mA, respectively (Example 1). A better resolution of analog output can be obtained if the limits are set, thus limiting the range of interest (Example 2).

Example 1: Range pH 0 - 14

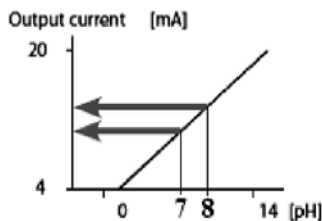

Example 2: Range pH 7 - 8

Advantage: Higher resolution in range of interest

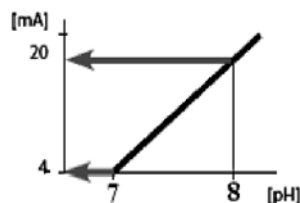

The output current is set to 0 mA when the analog output is disabled. Under range condition generates 4 mA whereas an over range condition generates 20 mA output current value.

8. OPERATIONAL GUIDE

8.1. CALIBRATION

pH Calibration

The pH electrode can be calibrated on the controller using an automatic, two-point calibration. The electrode should be calibrated:

- Before in-line or flow cell installation
- Whenever the pH electrode is replaced
- When higher accuracy is required
- After periodic maintenance

Always use fresh calibration buffers and perform recommended electrode maintenance prior to calibration.

Note: *It is recommended to choose calibration buffer solutions that bracket the pH sample.*

Preparation

Pour small quantities of the buffer solutions into clean beakers. If possible, use plastic beakers to minimize any EMC interferences. For accurate calibration and to minimize cross-contamination, use two beakers for each buffer solution; one for rinsing the electrode and one for calibration.

If measuring in the acidic range, use 4.01 pH as the first buffer and 7.01 pH as the second buffer.

If measuring in the alkaline range, use 7.01 pH as the first buffer and 10.01 pH as the second buffer.

A minimum of two-point calibration is required.

Press **MENU** to enter calibration mode. Select **pH options** by pressing **▼▲** and press **CAL**. 4.01 pH value is displayed blinking.

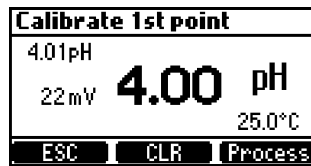

Remove the electrode protective cap and place the probe into the first buffer solution.

If the first buffer is 4.01 pH, "Recognized" is displayed followed by "Stable". Press **CFM** to accept the first calibration point.

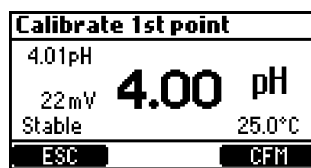

Place the probe into the second calibration buffer (either pH 7.01 or pH 10.01).

7.01 pH value starts blinking automatically. If the second buffer is 7.01 pH, "Recognized" is displayed followed by "Stable".

Press **CFM** to end calibration.

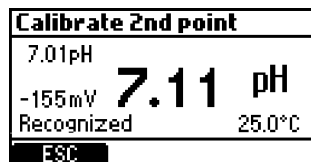

The "pH Calibration Complete" screen will appear briefly followed by the Menu screen. Press **MENU** to return to measurement mode.

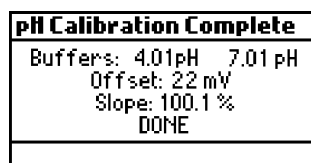

To delete a calibration, press CLR. Press YES to confirm or NO to exit and return to calibration screen.



If the temperature sensor detects extreme values during calibration, or is broken, a blinking 25.0 °C is displayed, indicating controller compensation for this temperature variation.

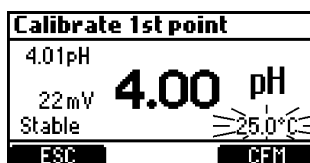

pH Calibration Error Messages

Wrong Buffer

Displayed when the difference between the pH reading and the value of the selected buffer is too high. Check that correct calibration buffer has been used.

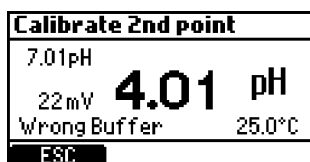

Invalid Slope

Displayed when the calculated slope is outside of the acceptable range.

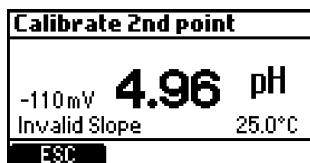

Clean Electrode

Message indicates poor electrode performance (offset is outside of the accepted window or slope is under the accepted lower limit). Clean the probe to improve the pH electrode's response and repeat calibration. See ELECTRODE CONDITIONING & MAINTENANCE for details.

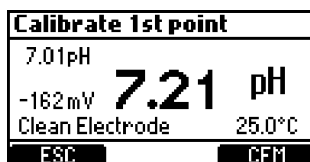

No Buffer Detected

Displayed if the probe has detected no buffer.

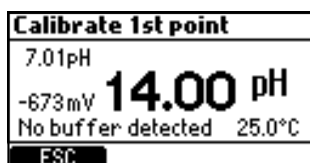

pH Process Calibration

Prior to performing a process calibration, use a calibrated hand held meter and probe to determine the pH of the process. Write the value down.

A process calibration allows the user to adjust the measured pH value so that it matches the value determined with the hand held meter and without removing the probe from the saddle.

pH process calibration is a single point calibration performed with the probe installed in the process. The calibration point is changed by using the ▼▲ keys. Press **Confirm** to save the calibration.

- The controller and the probe should have previously been calibrated in two buffers (so an electrode slope has been determined).
- Press **MENU** from measurement mode.
- Press the ▼▲ keys to select **pH options**.
- Press **CAL** to enter buffer calibration, then press the **Process** key.

Note: The CLR and Process keys are displayed only if the controller and the probe have been previously calibrated on the meter.

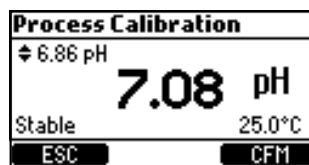

pH Process Calibration Error Messages

Maximum Window

Displayed if the limits (maximum or minimum) are reached.

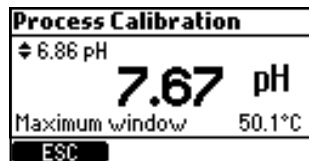

Inconsistency

Displayed if the pH value is out of range.

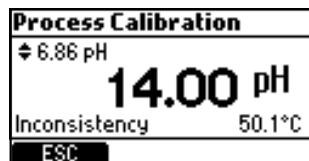

Set Calibration Point

Displayed if the onscreen value changes when pressing the ▼▲ keys. The displayed set point is automatically set to the current point limits.

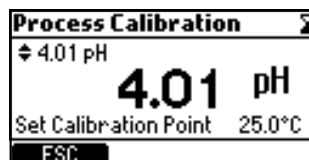

ORP Calibration

If both pH and ORP calibrations are required, calibrate the pH value first. A pH calibration can give inaccurate readings if the probe was used in ORP standard first.

Preparation

Pour small quantities of the ORP standard into clean beakers. If possible, use plastic beakers to minimize any EMC interferences. For accurate calibration and to minimize cross-contamination, use two beakers; one for rinsing the electrode and one for calibration.

Use the ▼▲ keys to set the value. Wait for “Stable” message to be displayed and press **CFM** to confirm calibration.



To clear a previous calibration, press **CLR** key. Press **YES** to confirm or **NO** to exit and return in the calibration screen.



A confirmation message is displayed next.

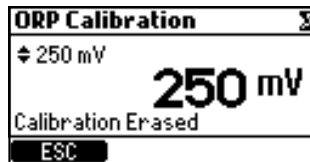

After pressing **CFM** in calibration, “DONE” message is displayed.

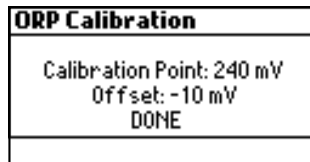

Rinse the probe under a running stream of water to remove ORP standard before installing in the saddle or flow cell. It may take several minutes to equilibrate in the pool water after exposure to the ORP standard.

GLP

Good Laboratory Practice (GLP) refers to a quality control function used to ensure uniformity of probe calibrations and measurements. To enter GLP information, press **MENU** key, select **pH options** or **ORP options** using the ▼▲ keys and press **GLP**.

If no calibration was made or the calibration was cleared, the controller displays the “No calibration available” message.

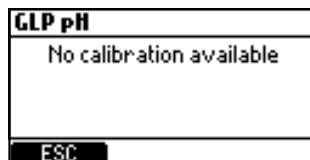

GLP information for pH and ORP is displayed separately.

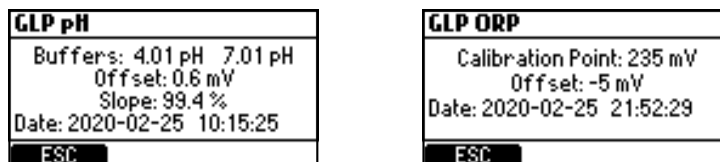

8.2. MEASUREMENT

Start the recirculation pump. Verify flow cell fills correctly (BL12X-20 only).

After setting up the pump controller, probe and required accessories the controller is ready.

Turn on the controller by switching ON/OFF button. After initialization has been completed, the controller displays the measurement screen.



A warning message will be displayed at startup if the Acid pump or Cl₂ Pump was not left in Auto mode when the controller was turned off.

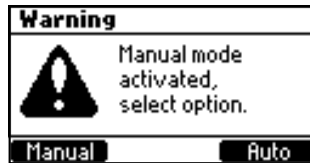

Select the Manual mode to prime pumps, check pump functions and ensure there are no leaks in the system.

Fittings may require tightening. Verify reagents are being pumped by selecting pH, then Cl₂ pumps.

To add additional time to Manual pump, press **Add 10s**. To verify probe is measuring, press **MENU**. A pH, mV and temperature value should be displayed.

- If **Auto** is selected, the controller enters in measurement screen, automatically selecting the Auto function for the pumps.
- If **Manual** is selected, the controller displays the MENU screen, allowing the pump status to be manually set. After setting the pumps, press **MENU** to enter measurement mode.

In Measurement mode, there are three display configurations. Press the ▼▲ keys to switch between the configurations.

- **Three parameters screen** — is the default screen, displayed at start up with all measured parameters.

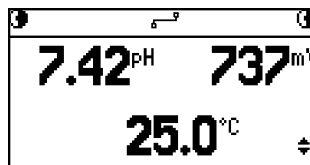



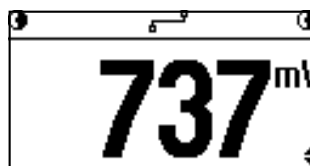



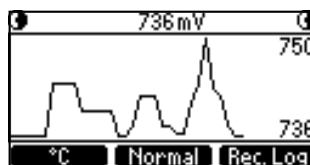

















- **Single parameter screen** — allows better viewing from a distance. The three parameters (pH, ORP and temperature), cycle automatically every 3 seconds.







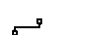

- **Real time plot screen** — is a plot representation of the last measurement for selected parameter. The first functional key selects the parameter and the title bar displays the current value for the selected parameter. The second functional key selects the Y axis zoom option: **Normal** (no zoom) and **Autosize** (zoom enabled). The **Rec. Log** functional key enters the controller logs.



In measurement mode the status bar displays the pumps status.

| BL120 & BL121 | | BL122 & BL123 | | Status Description |
|---|---|---|---|---|
|  |  |  |  | The pumps are on Manual status. |
|  |  |  |  | The pumps are on Manual status. |
|  |  |  |  | The ORP is waiting for the pH to reach Set Point. |
|  |  |  |  | Alarm status on the pumps. |
|  |  |  |  | There are active warnings. |
|  |  |  |  | The recirculation pump doesn't work. |
| | |  |  | The HOLD mode was remotely activated. |

Screen status messages (BL122 & BL123)

| | |
|---|---------------------------------------|
|  | Connecting |
|  | Connected |
|  | Disconnected. Physical network issues |
|  | Disconnected. Cloud connection issues |
|  | Sending messages |
|  | Disabled |

8.3. CONTROLLER FUNCTIONING MODES (OVERVIEW)

The Controller Menu

The controller menu is grouped into seven categories:

- Acid (or base) pump control
- Cl₂ pump control
- pH options (CAL, Setup, GLP)
- ORP options (CAL, Setup, GLP)
- Temperature options (Setup)
- Hanna Cloud options (BL122 & BL123)
- General options

Control Mode

The Control Mode is the normal operational mode during which the controller:

- Measures the [HI1036-18XX](#) probe's signal, converts it to a measurement unit (pH temperature corrected), and displays the measurements together with temperature.
- Provides proportional feed with an adjustable band for acid and chlorine additions.
- Controls the alarm relays and analog outputs ([BL121](#), [BL123](#)), as per setup configuration.
- Sends data to Hanna Cloud ([BL122](#), [BL123](#)).
- Displays active events on the LCD.
- Activates the LEDs for quick visual feedback.
- Ensures the pH-ORP control interlock (the ORP control is running only when the pH set point is reached).
- Automatically logs pH / ORP /temperature measurements, last calibration data, setup configuration, event data.
- Allows access to logged data in view mode / export operation / PLOT.

In control mode, the dosing pumps are regulated by using the proportional feed. Proportional feed regulates pump On / Off time within the band. The pump remains On continuously at the set point with band added. As the set point is approached, the pump is On less.

In control mode, the **Overtime** safety timer will run during the On pump period and is reset when the set point is reached.

| | pH control | ORP control |
|-------------------|----------------|-------------|
| Dosing Type | ACID/BASE | |
| Set Point | 6.00 – 8.00 pH | 200– 900 mV |
| Proportional band | 0.1– 2.0 pH | 10– 200 mV |

The plot shows how the dosing time is affected by this difference.

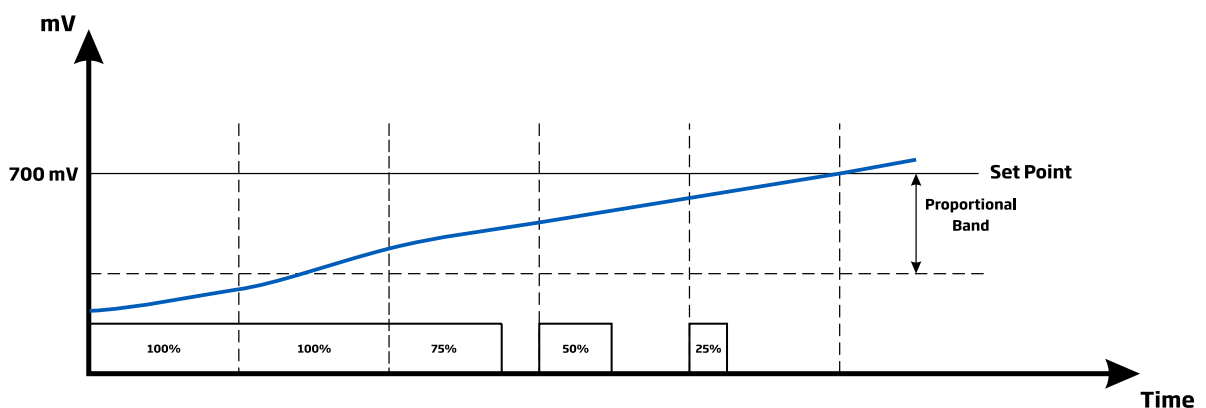
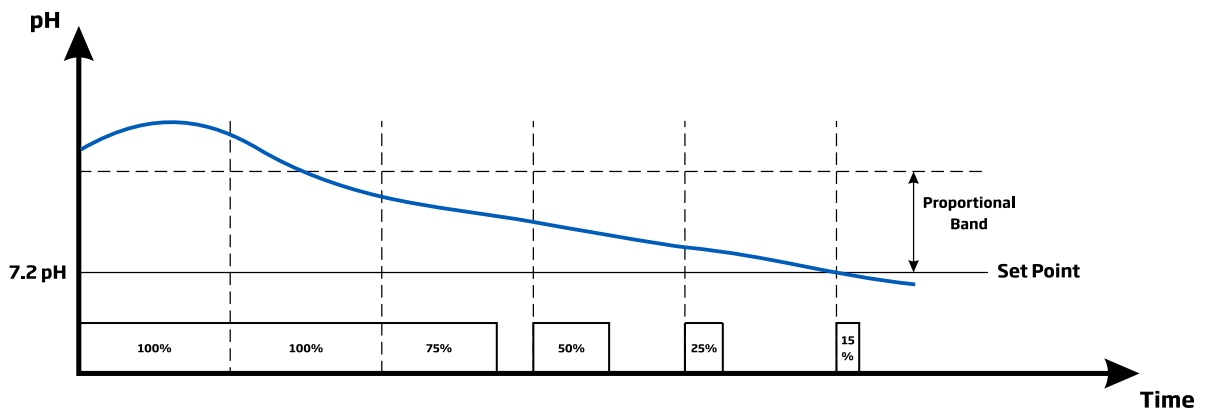

An overview of pH and ORP proportional control is presented in the graph below.

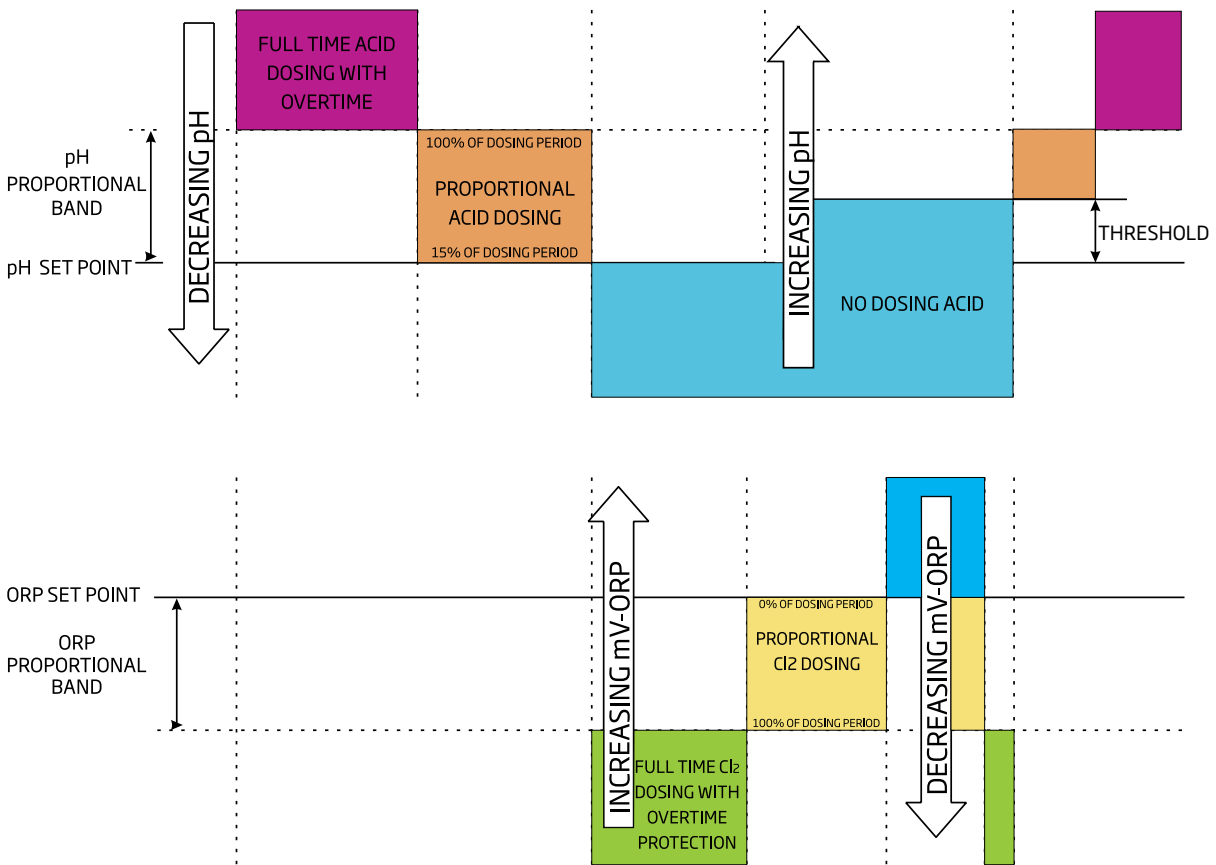

LEDs status ● STATUS ○ SERVICE ● pH/Chlorine (controlling and pump off) ☀ (controlling and pump run)

The alarm relay is energized (no alarms).

Analog outputs follow the assigned parameters based on settings (BL121, BL123).

Reagent pumps are disabled:

- immediately after power-on for a period of time defined in pH / ORP Startup dosing delay
- when acid pump is OFF (manually controlled)
- if one or more high / low alarms and / or process errors are active
- when the Hold Input or Remote Hold events are active
- pump operation has exceeded time set in the Overtime safety timer selection
- upon entering Setup

Manual / Auto Pump Control for pH or Chlorine Control

Each pump can be set to MANUAL control by selecting the On 10s / OFF options.

When On 10s is selected the pump runs continuously for 10s. To increase the time up to 90 seconds, press the Add 10s button. The remaining time is displayed next to the selected pump in the menu. Pressing the OFF button will stop the pump. To return to the automatic mode, select Auto for each pump. In Auto mode the pumps will be activated when the measurement reaches the set point value.

8.4. LOGGING

The controller logging system offers an automatic save mode for all parameters (pH, ORP, Temperature) and the following events:

- High and Low alarms
- Overtime errors
- Hold Input
- Remote Hold
- Low tank level for acid or chlorine tanks
- Manual Mode
- Power failure
- Probe being reconnected

Logged data is stored in the internal controller memory.

A new log is generated if any of the following settings are changed: controller ID, the date /time, decimal point or any setting from pH / ORP / Temperature menu.

8.5. LOG RECALL

Logged data can be viewed on the controller in standard mode or plot mode.

- To access the logged data, press the ▼▲ keys from measurement mode, to display the real-time plot mode screen. Press **Rec. Log** key.

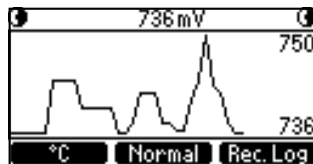

- The controller can hold up to 100 logs.
- The Log Recall summary screen displays the list with all available logs, with the most recent log displayed at the top.

| Log Recall Summary | |
|--------------------|---------------|
| 001. | 2020-02-25 03 |
| 002. | 2020-02-25 02 |
| 003. | 2020-02-25 01 |
| 004. | 2020-02-25 |

ESC Plot -->

- If the settings are changed, multiple logs from same day will be displayed with different index.

| Log Recall Summary | |
|--------------------|---------------|
| 001. | 2020-02-25 03 |
| 002. | 2020-02-25 02 |
| 003. | 2020-02-25 01 |
| 004. | 2020-02-25 |

<-- Details Options

The **Log Recall** function can be accessed via two screens. To switch between the screens use --> and <-- keys.

- Use the ▼▲ keys to select the day.
- To view the logs in plot mode, press **Plot**.
- To view the logs in Normal mode, press **Details**. The record values are displayed: pH, ORP and temperature. Press the ▼▲ keys, to scroll through the records. Current index number is displayed in the right corner of the title bar.

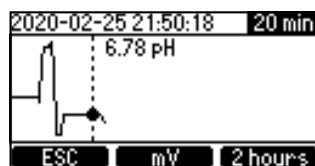

Three screens display record details.

- Press 1 / 3, 2 / 3 or 3 / 3 to view more details. The Plot can be activated by pressing **Plot**.

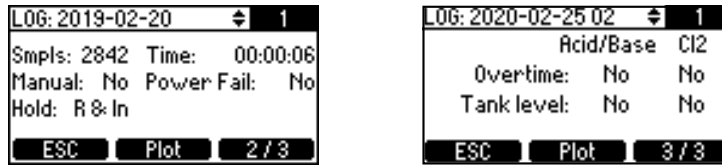

- If in the Log Recall summary screen the **Option** key is selected, the following screen is displayed.



- Users can select one of the three options: export current log, export all logs, delete all logs.
- Unscrew the USB cover to insert the USB stick.
- Press **CFM** to continue or **ESC** to return to the previous screen.
- When an export option is selected, "Transfer in progress" is displayed on screen while the data is transferred and saved to the USB stick. Data is saved in a folder named after the controller ID.

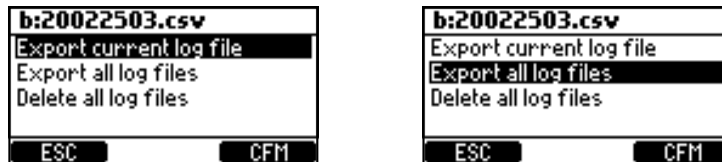

- All logs can be deleted by selecting Delete all log files option and pressing **CFM**.



Logged data is formatted as comma separated values (*.CSV) and can be opened with any text editor or spreadsheet program. Click on the desired log to view data.

Logs are designated with year, month, day and index code YYMMDDNN.CSV.

For example 20022503.CSV represents the log with index number 03 from February 25, 2020.

Suggested settings for correct formatting: comma or period, Western Europe character set (ISO-88859-1) and English language.

9. EVENT MANAGEMENT

BL12X controllers have an intuitive, user-friendly events management system that allows for a quick identification of event sources.

The signaling is done by using STATUS and SERVICE LEDs located on the front panel.

The STATUS LED is a multicolor, red-yellow-green LED that indicates the controller status based on traffic light concept (🟢 Green - "OK", 🟡 Yellow - "Need attention" and 🔴 Red - "Something wrong").

The SERVICE LED indicates that service is required or the controller is in Manual mode.

All active events are easily visualized by pressing the HELP key while the controller is in view parameter screens.

The four event types managed by the controller are filtered using the setup options.

- WARNINGS (!) - non critical event: Start-up delay active, No user calibration, power-failed, High and Low alarm warnings (Events timeout)
- ALARMS (A) - measurements have exceeded the specified High and Low limits
- PROCESS ERRORS (E) - Out of range, hold input active, remote hold active, tanks level input active
- SYSTEM ERRORS - Critical errors

9.1. WARNINGS

Warning messages are triggered by non-critical events.

- **No pH user calibration** (calibration was cleared) - active only if "Menu\pH options\Warnings and Errors
- **No ORP user calibration** (calibration was cleared) - active only if "Menu\ORP options\Warnings and Errors
- **pH control delayed** (acid regulator is in delay after a power-on)
- **ORP control delayed** (Cl2 regulator is in delay after a power-on)
- **Warnings High/Low pH/ORP/Temp** - active if the desired alarm is enabled, the alarm level is exceeded and the set timeout value (defined to trigger the alarm) was not exceeded. "Menu\General\Events Timeout x min"
- **Overheating dosing delay** (pump control is disabled due to overheating condition) active only if the pump driver temperature is over the accepted limit
- **Communication disabled** (BL122, BL123)
- **No connection to Hanna Cloud** (BL122, BL123)

Warning Specifications

- A warning event related to pH/ORP/Temperature is evaluated only if it's enabled. It will not appear if "Event Timeout 0 min".
- The alarm relay is not controlled by warning events.
- The buzzer is not controlled by warning events.
- The warning event does not influence the dosing.
- The warnings are indicated by an "!" message displayed close to related pump icon.
- Selecting Help on measurement screens will display the active alarms.

9.2. ALARMS

Alarms are triggered by measured data exceeding configured high or low limits. Values are user selectable and can be enabled or disabled from the parameter option Menu.

Alarm Specifications

- An alarm condition is evaluated only if that condition is enabled.
- The alarm is triggered immediately if the **Events Timeout** is set to 0 min. Otherwise, the alarm will be delayed as configured and will appear as a warning until the period has expired, and then it will become an alarm.
- Alarm evaluation is done at 1 second interval after a new measurement cycle.
- The alarm is triggered if the event persists a minimum of 5 consecutive samples.
- An active alarm deenergizes the **Alarm Relay**, if the relay control parameter is enabled.
- If the error beep is enabled, each time an alarm is triggered, a beep will be generated.
- All alarms are logged and visible in **Log RCL**.

Note: The logging period is higher than the measure period. Any alarm condition that occurred between logging moments is captured and logged even if the alarm conditions are no longer active on first log (event) after the alarm.

Any alarm condition will inactivate the dosing pumps. During an alarm condition:

- An $\bar{\uparrow}$ (High alarm) \downarrow (Low alarm) icon will appear close to parameter value which triggered the alarm.
- STATUS LED will turn RED and start blinking.
- SERVICE LED will start blinking.
- The regulator pump status LEDs will be Off.
- The ALARM message is displayed close to the pump icon.
- Help on measurement screens will display the active alarms.

9.3. PROCESS ERRORS

Process errors are errors that could occur during process and may affect the pH control, ORP control or both.

Possible events:

- **No probe** — triggered if probe is disconnected.
- **Hold input active** (the recirculation pump doesn't work) — triggered only if Hold input is enabled.
- **Remote Hold** (Deactivate the pumps, [BL122](#) & [BL123](#)) — remotely triggered by user when checking the Remote Hold check box in General Settings tab. After it has been triggered, a notification message will appear on LCD. The remote hold can be canceled immediately by pressing **YES**, or later, by pressing **R-HOLD** available in "Menu\Hanna Cloud Option".

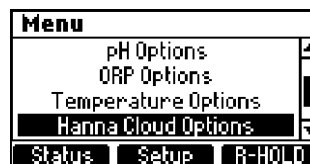

- **pH out of range** — triggered if:
"Menu\pH options\Warnings and Errors
- **ORP out of range** — triggered if:
"Menu\ORP options\Warnings and Errors
- **Temperature out of range** — triggered if:
"Menu\Temperature options\Warnings and Errors
- **Low level in acid/base tank** — triggered if a level sensor is used:
"Menu\pH options\Setup\Acid/base tank Input
- **Low level in Cl₂ tank** — triggered if a level sensor is used:
"Menu\ORP options\Setup\Cl₂ tank Input
- **pH dosing overtime** — triggered if the acid pump is dosing full time or is dosing in proportional control band for more than value specified in settings. See:
"Menu\pH options\Setup\Overtime xxxmin"
- **ORP dosing overtime** — the Cl₂ pump is dosing full time or is dosing in proportional control band for more than value specified in settings. See:
"Menu\ORP options\Setup\Overtime xxxmin"

Note: pH/ORP dosing overtime process errors are erased only at controller restart or by Manual control.

The overtime counters are reset when Hold Input is active.

Process Error Specifications

- A process error condition is evaluated only if it's enabled.

Note: "No probe", "Hold input active" and "Remote Hold" are not dependent on "Warnings and Errors

- An active alarm deenergizes the **Alarm Relay** if the **Alarm Activates Relay** is enabled.

Example: “Menu\pH options\Alarm Activates Relay ” for pH related errors

- A beep is generated each time an error is triggered if **Alarms and Errors Beep** is enabled.
- All errors are logged and visible in log RCL.
- Any error condition will inactivate the dosing pumps. After an error has been signaled:
 - STATUS LED will turn red and the SERVICE LED will blink.
 - The regulator pump status LED will be off.
 - The following messages can be displayed close to the related pump icon:
 - ERROR - Out of range and overtime errors
 - TANK - Low level in Acid/Base and Cl₂ tanks
 - R-HOLD blinking - Hold mode remotely activated
 - HOLD - Hold input (recirculation pump)
 - The Help of measurement screens will display the active errors.

9.4. SYSTEM ERRORS

These events are continuously monitored. One or more events will put the controller in ERROR mode to avoid unpredictable behavior.

When the controller enters ERROR mode it:

- Stops the dosing pumps
- Stops the logging
- Activates the alarm relay (relay not energized)
- Generates repetitive beep messages
- STATUS LED is blinking in red
- SERVICE LED On
- Turns the pumps Off
- Displays a dedicated error screen with the error code.

The error code is the OR of all errors detected:

- 0x0002 Eeprom malfunctions
- 0x0100 Generated when 24V power supply voltage is out of range
- 0x0200 Generated when 5V power supply voltage is out of range
- 0x0400 Generated when 3V power supply voltage is out of range
- 0x0800 Generated when USB power consumption is out of range
- 0x2000 Generated when probe power voltage is out of range
- 0x4000 Generated when analog outputs power voltage is out of range (BL121, BL123)
- 0x8000 Generated when thermal hardware protector is active
- 0x40000 Generated when internal temperature has malfunctions



This screen will block access to the other screens.

The table describes LEDs status, dosing pumps, measurement and logging processes for different controller modes.

| Modes | Events | LEDs | | | | Dosing pumps | | Measure | Logging | |
|-----------------------------------|--|--|---------|-----|-----------------|--------------|-------------------------------------|-------------------------------------|-------------------------------------|-------------------------------------|
| | | STATUS | SERVICE | pH | Cl ₂ | pH | Cl ₂ | | | |
| RUN | With dosing delay at start-up | | | | | Off | Off | <input checked="" type="checkbox"/> | <input checked="" type="checkbox"/> | |
| | No dosing | | | | | Auto-Off | Auto-Off | <input checked="" type="checkbox"/> | <input checked="" type="checkbox"/> | |
| | Dosing Acid | | | ☼ | | Auto-On | Auto-Off | <input checked="" type="checkbox"/> | <input checked="" type="checkbox"/> | |
| | Dosing Chlorine | | | | ☼ | Auto-Off | Auto-On | <input checked="" type="checkbox"/> | <input checked="" type="checkbox"/> | |
| | Pump Cl ₂ Manual | High or Low alarms active | ☼ | | ☼ | | Auto-Wait | Manual Off/On | <input checked="" type="checkbox"/> | <input checked="" type="checkbox"/> |
| | | No active alarms | | | ☼ | | Auto-Wait | Manual Off/On | <input checked="" type="checkbox"/> | <input checked="" type="checkbox"/> |
| | Pump pH Manual | High or Low alarms active | ☼ | | ☼ | | Manual Off/On | Auto-Wait | <input checked="" type="checkbox"/> | <input checked="" type="checkbox"/> |
| | | No active alarms | | | ☼ | | Manual Off/On | Auto-Wait | <input checked="" type="checkbox"/> | <input checked="" type="checkbox"/> |
| | Warnings | High pH warning active | ☼ | | ☼ | | Auto-On | Off | <input checked="" type="checkbox"/> | <input checked="" type="checkbox"/> |
| | | Low pH warning active | ☼ | | (☼) | | Auto-Off | On | <input checked="" type="checkbox"/> | <input checked="" type="checkbox"/> |
| | | High ORP warning active | ☼ | | | | Auto-Off | On | <input checked="" type="checkbox"/> | <input checked="" type="checkbox"/> |
| | | Low ORP warning active | ☼ | | | ☼ | Auto-Off | On | <input checked="" type="checkbox"/> | <input checked="" type="checkbox"/> |
| | | High or Low Temperature active | ☼ | | (☼) | (☼) | Auto | Auto | <input checked="" type="checkbox"/> | <input checked="" type="checkbox"/> |
| No logging (no alarms) | | | (☼) | (☼) | Auto | Auto | <input checked="" type="checkbox"/> | <input type="checkbox"/> | | |
| No cloud connectivity (no alarms) | | | (☼) | (☼) | Auto | Auto | <input checked="" type="checkbox"/> | <input type="checkbox"/> | | |
| HOLD | Run pH or ORP user calibration | | | | | Off | Off | <input checked="" type="checkbox"/> | <input type="checkbox"/> | |
| | Change settings (SETUP) | | | | | Off | Off | <input checked="" type="checkbox"/> | <input type="checkbox"/> | |
| MANUAL | Pump Acid On | High or Low alarms active | ☼ | | ☼ | Manual-On | Manual-Off | <input checked="" type="checkbox"/> | <input checked="" type="checkbox"/> | |
| | | No active alarms | | | ☼ | Manual-On | Manual-Off | <input checked="" type="checkbox"/> | <input checked="" type="checkbox"/> | |
| | Pump Cl ₂ On | High or Low alarms active | ☼ | | ☼ | Manual-Off | Manual-On | <input checked="" type="checkbox"/> | <input checked="" type="checkbox"/> | |
| | | No active alarms | | | ☼ | Manual-Off | Manual-On | <input checked="" type="checkbox"/> | <input checked="" type="checkbox"/> | |
| | Both On | High or Low alarms active | ☼ | | ☼ | ☼ | Manual-On | Manual-On | <input checked="" type="checkbox"/> | <input checked="" type="checkbox"/> |
| No active alarms | | | | ☼ | ☼ | Manual-On | Manual-On | <input checked="" type="checkbox"/> | <input checked="" type="checkbox"/> | |
| No probe | --- | ☼ | | (☼) | (☼) | Manual | Manual | <input checked="" type="checkbox"/> | <input checked="" type="checkbox"/> | |
| ALARMS & PROCESS ERRORS | Alarm | High or Low pH | ☼ | ☼ | | | Auto-Off | Auto-Off | <input checked="" type="checkbox"/> | <input checked="" type="checkbox"/> |
| | | High or Low ORP | ☼ | ☼ | | | Auto-Off | Auto-Off | <input checked="" type="checkbox"/> | <input checked="" type="checkbox"/> |
| | | High or Low Temperature | ☼ | ☼ | | | Auto-Off | Auto-Off | <input checked="" type="checkbox"/> | <input checked="" type="checkbox"/> |
| | Hold In | High/Low warning or alarm active | ☼ | | | | Auto-Off | Auto-Off | <input checked="" type="checkbox"/> | <input checked="" type="checkbox"/> |
| | | No High/Low warning or alarm active | | | | | Auto-Off | Auto-Off | <input checked="" type="checkbox"/> | <input checked="" type="checkbox"/> |
| | Remote Hold | Hold mode remotely activated | | | | | Auto-Off | Auto-Off | <input checked="" type="checkbox"/> | <input checked="" type="checkbox"/> |
| | Overtime pH | High / Low warning or alarm active | ☼ | ☼ | | | Auto-Off | Auto-Off | <input checked="" type="checkbox"/> | <input checked="" type="checkbox"/> |
| | | No High/Low warnings, No alarms active | | ☼ | | | Auto-Off | Auto-Off | <input checked="" type="checkbox"/> | <input checked="" type="checkbox"/> |
| | Overtime Cl ₂ | High / Low warning or alarm active | ☼ | ☼ | | | Auto-Off | Auto-Off | <input checked="" type="checkbox"/> | <input checked="" type="checkbox"/> |
| | | No High/Low warnings, No alarms active | | ☼ | | | Auto-Off | Auto-Off | <input checked="" type="checkbox"/> | <input checked="" type="checkbox"/> |
| | Low Level Acid tank | High / Low warning or alarm active | ☼ | ☼ | | | Auto-Off | Auto-Off | <input checked="" type="checkbox"/> | <input checked="" type="checkbox"/> |
| | | No High/Low warnings, No alarms active | | ☼ | | | Auto-Off | Auto-Off | <input checked="" type="checkbox"/> | <input checked="" type="checkbox"/> |
| | Low Level Cl ₂ tank | High / Low warning or alarm active | ☼ | ☼ | (☼) | | Auto | Auto-Off | <input checked="" type="checkbox"/> | <input checked="" type="checkbox"/> |
| | | No High/Low warnings, No alarms active | | ☼ | (☼) | | Auto | Auto-Off | <input checked="" type="checkbox"/> | <input checked="" type="checkbox"/> |
| | pH Under/Over range | | ☼ | ☼ | | | Auto-Off | Auto-Off | <input checked="" type="checkbox"/> | <input checked="" type="checkbox"/> |
| ORP Under/Over range | | ☼ | ☼ | | | Auto-Off | Auto-Off | <input checked="" type="checkbox"/> | <input checked="" type="checkbox"/> | |
| Temp Under/Over range | | ☼ | ☼ | | | Auto-Off | Auto-Off | <input checked="" type="checkbox"/> | <input checked="" type="checkbox"/> | |
| No probe | | ☼ | ☼ | | | Auto-Off | Auto-Off | <input checked="" type="checkbox"/> | <input type="checkbox"/> | |
| No Factory Calibration | | ☼ | ☼ | | | Auto-Off | Auto-Off | <input checked="" type="checkbox"/> | <input checked="" type="checkbox"/> | |
| No User Calibration | | ☼ | ☼ | | | Auto-Off | Auto-Off | <input checked="" type="checkbox"/> | <input checked="" type="checkbox"/> | |
| SYSYEM ERROR | Critical hardware errors (power, internal temperature, I ₂ C) | ☼ | | | | Off | Off | <input checked="" type="checkbox"/> | <input type="checkbox"/> | |

☼ -blinking when Manual-On, off when Manual Off

(☼)-depending on pH-ORP regulators status

10. MAINTENANCE

10.1. ELECTRODE CONDITIONING & MAINTENANCE

Preparation

Remove the electrode protective cap.

Do not be alarmed if any salt deposits are present. This is normal with electrodes and they will disappear when rinsed with water. During transport tiny bubbles of air may have formed inside the glass bulb. The electrode cannot function properly under these conditions. These bubbles can be removed by “shaking down” the electrode as you would do with a clinical thermometer. If the bulb and/or junction are dry, soak the electrode in [HI70300](#) Storage solution for at least one hour.

Storage

To minimize clogging and ensure a quick response time, the glass bulb and the junction should be kept hydrated and not allowed to dry out. This can be achieved by installing the electrode in such a way that it is constantly in the flow cell or the pipe filled with the sample.

When not in use, replace the solution in the protective cap with a few drops of [HI70300](#) Storage solution or, in its absence, [HI7082](#) KCl 3.5M solution.

Follow the Preparation procedure above before taking any measurements.

Note: Never store the electrode in distilled or deionized water.

10.2. PUMP TUBING REPLACEMENT

For pump tubing replacement please wear protective gloves and eye protection at all times; and follow the steps below:

1. Power off the controller.
2. Disconnect the tubing from the pumps.
3. Unscrew and remove the plastic cover from the pumps.

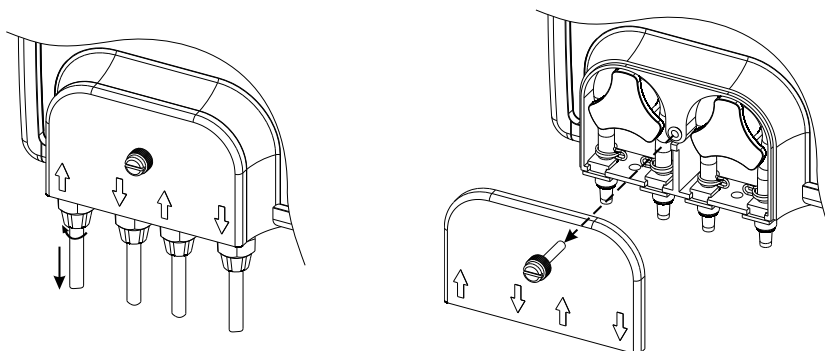

4. Starting from the left side of the pump, grab the tubing and rotate the pump rotor manually to the right, until the tubing is removed.

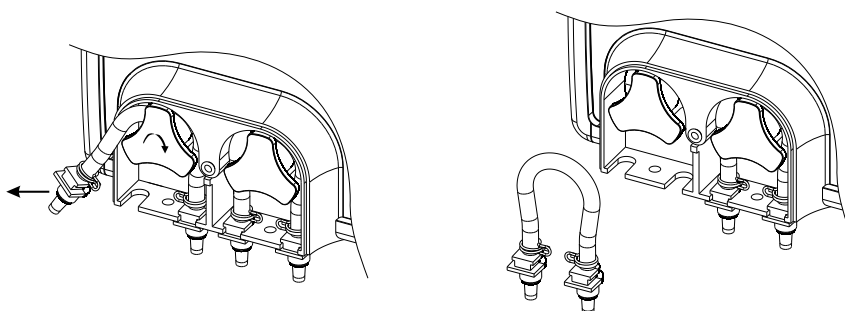

5. Take the new tubing and place it on the left side of the pump and start to manually rotate the pump rotor to the right until the tubing is on the pump.

6. Fix the plastic holder in its place on the right and left side.

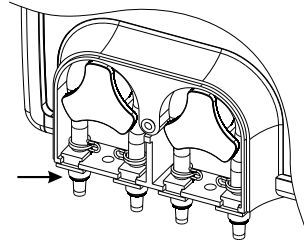
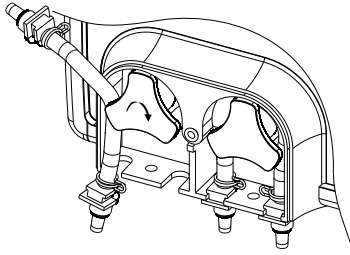

7. Place the plastic cover. Reattach the tubings to the pumps.

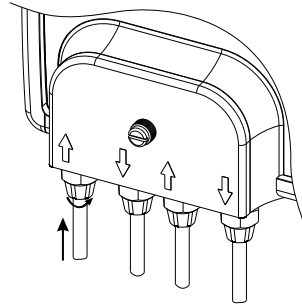
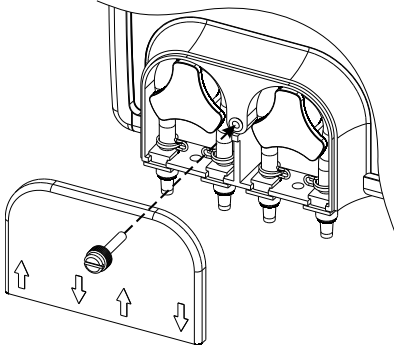

11. ACCESSORIES

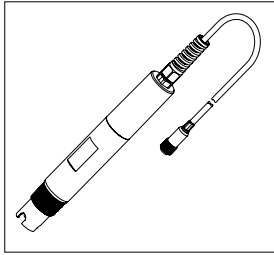

HI1036-18XX*
Industrial pH / ORP /
Temperature / Matching Pin
combined probes

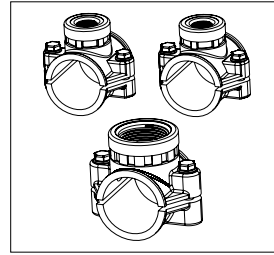

BL120-150
Fittings kit for Ø 50 mm pipe

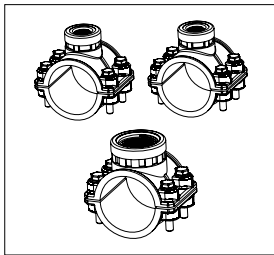

BL120-163
Fittings kit for Ø 63 mm pipe

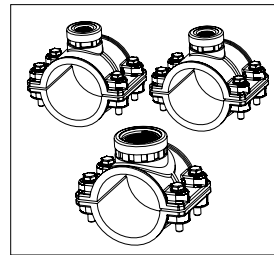

BL120-175
Fittings kit for Ø 75 mm pipe

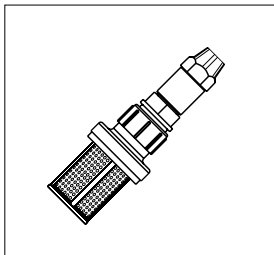

BL120-200
Pool controller aspiration filter

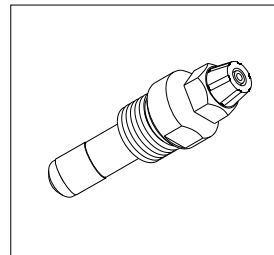

BL120-201
Pool controller injector,
1/2" thread

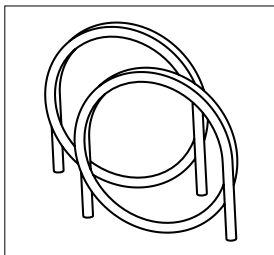

BL120-202
Aspiration and dispensing
tubing (5+5 m)

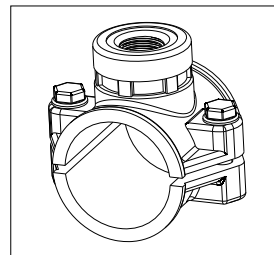

BL120-250
Injector saddle for Ø 50 mm
pipe, 1/2" thread

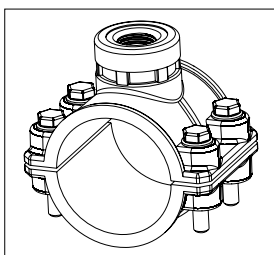

BL120-263
Injector saddle for Ø 63 mm
pipe, 1/2" thread

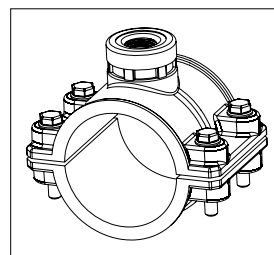

BL120-275
Injector saddle for Ø 75 mm
pipe, 1/2" thread

* where XX is: 02, 05, 10, 15, 20 attached cable length

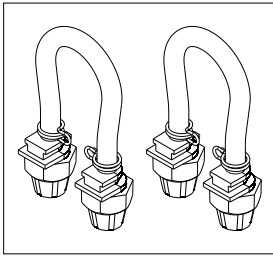

BL120-300
Pool controller peristaltic pump tubing kit (2 pcs.)

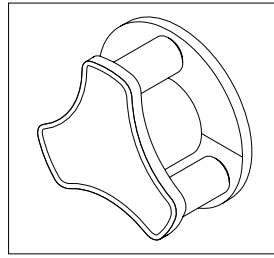

BL120-301
Pool controller peristaltic pump rotor

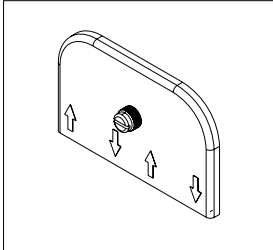

BL120-302
Pool controller pump cover with screw

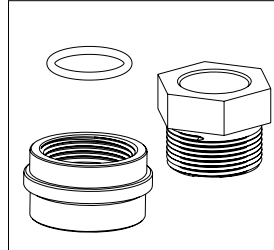

BL120-400
Flow cell probe adapter kit

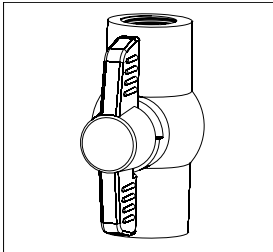

BL120-401
Flow cell valve

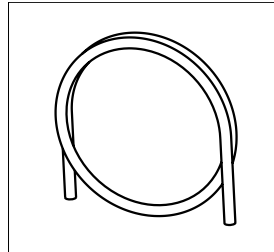

BL120-402
Flow cell tubing (10 m)

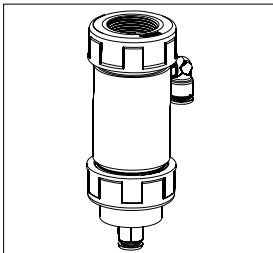

BL120-410
Flow cell for BL120, BL121, BL122, BL123

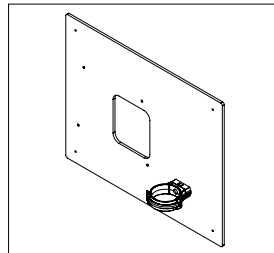

BL120-411
Flow cell panel spare part

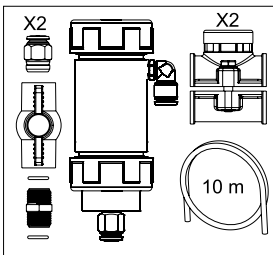

BL120-450
Flow cell kit for Ø 50 mm pipe

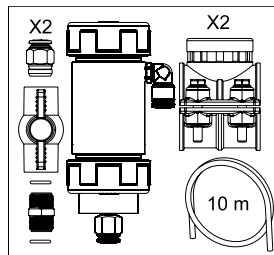

BL120-463
Flow cell kit for Ø 63 mm pipe

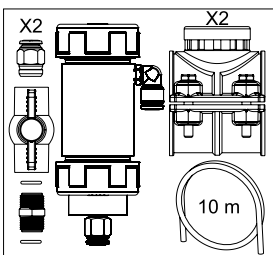

BL120-475
Flow cell kit for Ø 75 mm pipe

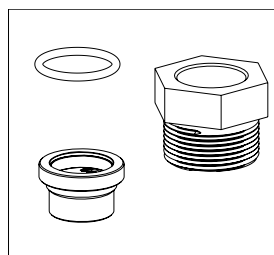

BL120-500
Probe fitting kit

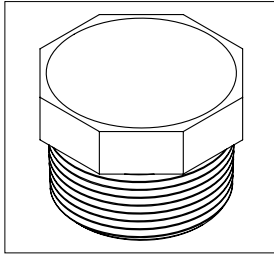

BL120-501
Protective saddle cap,
1 - 1/4" thread

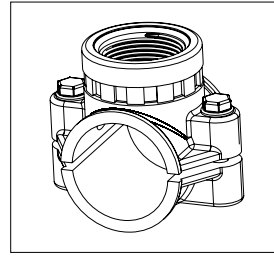

BL120-550
Probe saddle for Ø 50 mm
pipe, 1 - 1/4" thread

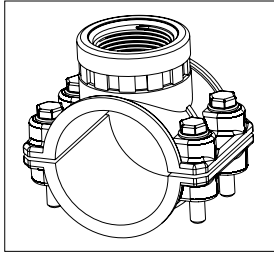

BL120-563
Probe saddle for Ø 63 mm
pipe, 1 - 1/4" thread

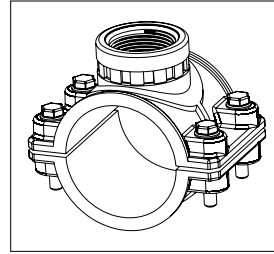

BL120-575
Probe saddle for Ø 75 mm
pipe, 1 - 1/4" thread

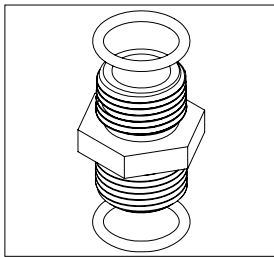

BL120-601
Plastic nipple 2 x 1/2" with
O-rings

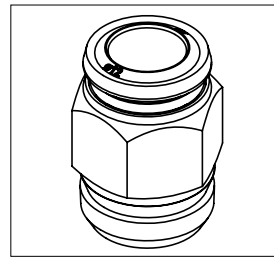

BL120-602
Metal nipple 12 x 1/2"
(2 pcs.)

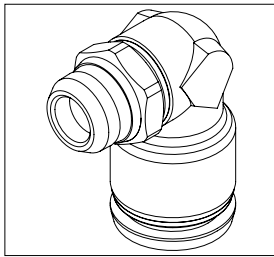

BL120-603
Elbow for glass flow cell

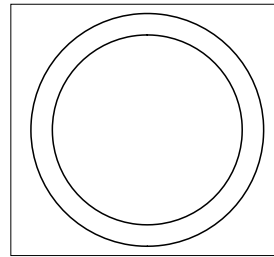

BL120-604
O-ring for glass flow cell

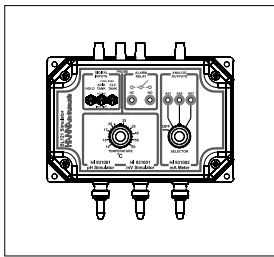

BL120-901
Simulator for BL120, BL121,
BL122, BL123

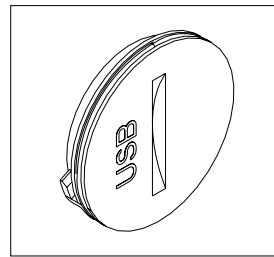

BL120-902
USB protective cap

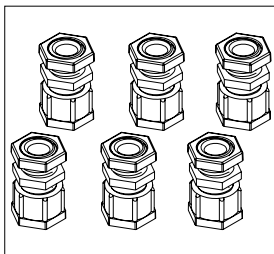

BL120-903
Cable gland protective kit
(6 pcs.)

HI740036P Plastic beaker set, 100 mL (10 pcs.)

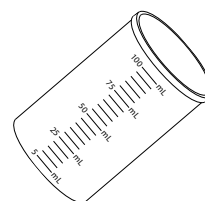

ELECTRODE STORAGE SOLUTIONS

HI70300L Storage solution, 500 mL

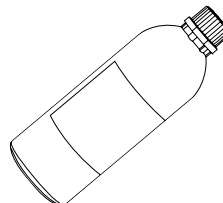

BUFFER SOLUTIONS

HI70004P pH 4.01 buffer sachets, 20 mL (25 pcs.)

HI70007P pH 7.01 buffer sachets, 20 mL (25 pcs.)

HI70010P pH 10.01 buffer sachets, 20 mL (25 pcs.)

HI7004L pH 4.01 buffer solution, 500 mL

HI7007L pH 7.01 buffer solution, 500 mL

HI7010L pH 10.01 buffer solution, 500 mL

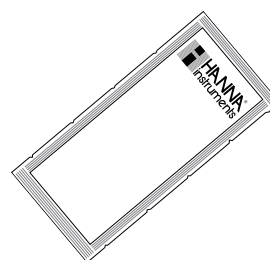

ORP SOLUTIONS

HI7021L ORP test solution, 240 mV @ 25 °C, 500 mL

HI7022L ORP test solution, 470 mV @ 25 °C, 500 mL

HI7091L Reducing pre-treatment solution for ORP electrodes, 500 mL

HI7092L Oxidizing pre-treatment solution for ORP electrodes, 500 mL

HI70022P ORP test solution, 470 mV @ 25 °C, 20 mL (25 pcs.)

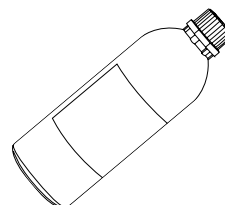

CERTIFICATION

All Hanna[®] instruments conform to the CE European Directives.



Disposal of Electrical & Electronic Equipment. The product should not be treated as household waste. Instead, hand it over to the appropriate collection point for the recycling of electrical and electronic equipment, which will conserve natural resources.

Disposal of waste batteries. This product contains batteries, do not dispose of them with other household waste. Hand them over to the appropriate collection point for recycling.



Ensuring proper product and battery disposal prevents potential negative consequences for the environment and human health, which may be caused by inappropriate handling. For more information, contact your city, your local household waste disposal service, or the place of purchase.

RECOMMENDATIONS FOR USERS

Before using this product, make sure it is entirely suitable for your specific application and for the environment in which it is used. Any variation introduced by the user to the supplied equipment may degrade the controller's performance. For your and the controller's safety do not use or store the controller in hazardous environments.

WARRANTY

This controller is warranted for two years (the probe for six months) against defects in workmanship and materials when used for its intended purpose and maintained according to instructions. This warranty is limited to repair or replacement free of charge. Damage due to accidents, misuse, tampering or lack of prescribed maintenance is not covered.

If service is required, contact your local Hanna Instruments[®] office. If under warranty, report the model number, date of purchase, serial number (engraved on the bottom of the meter) and the nature of the problem. If the repair is not covered by the warranty, you will be notified of the charges incurred. If the instrument is to be returned to Hanna Instruments, first obtain a Returned Goods Authorization (RGA) number from the Technical Service department and then send it with shipping costs prepaid. When shipping any instrument, make sure it is properly packed for complete protection.

Hanna Instruments reserves the right to modify the design, construction or appearance of its products without advance notice.

World Headquarters

Hanna Instruments Inc.
Highland Industrial Park
584 Park East Drive
Woonsocket, RI 02895 USA
www.hannainst.com